

ADHESIVES AND SEALANTS FOR THE COMMERCIAL VEHICLE INDUSTRY



KÖMMERLING – YOUR COMPETENT PARTNER FOR ADHESIVES AND SEALANTS

KÖMMERLING has been engaged in the development, production and marketing of high-performance adhesives and sealants for more than 100 years.

KÖMMERLING set the standard as long ago as 1949 when it produced the world's first contact adhesive based on synthetic rubber. Further milestones followed in the 50s and 60s in the field of high quality adhesives and sealants for several industrial areas. In subsequent decades KÖMMERLING has continued to expand its product range. On-going developments in, for example, the field of elastic adhesives and sealants based on polyurethane or silane terminated products have led to the establishment of an extensive product range for different applications.

We recognise the need to work together with our customers to develop individual solutions, achieving technical advances in the process. In particular, in the commercial vehicle industry which is one of the core markets for KÖMMERLING, we have developed a comprehensive range of products and system solutions by working in close co-operation with the market leaders in these fields.

In the commercial vehicle sector, KÖMMERLING is well known as a leading expert for sealing and bonding solutions. Our expertise has been acquired from many years of practical experience.

In addition to its headquarters in Pirmasens, Germany, KÖMMERLING has subsidiaries in France, United Kingdom, Russia, USA and China. Innovation and service, combined with a global sales and distribution network make KÖMMERLING the ideal partner for you.





PRODUCT OVERVIEW

1

KÖRACOLL

Aqueous dispersion adhesive,
one and two component

2

KÖRAPLAST

Solvent based PUR adhesive,
one and two component

3

KÖRAMELT

Thermoplastic and reactive
hot melt adhesive

4

KÖDITEC / KÖDISIL

Silicone based sealants, good resistance
to UV, temperature and oil

5

KÖRAPUR

Polyurethane adhesives and sealants,
one and two component

6

KÖDIPLAST

Butyl sealants

7

KÖRAPOX

Epoxy resin adhesives and coatings,
two component

8

KÖRATAC

Cyanoacrylate and
polymer adhesives

9

KÖRAPOP

Polyoxypropylene adhesives and sealants,
one and two component

10

KÖRAPREN

Solvent based polychloroprene rubber
contact adhesive

11

KÖRATAPE

Acrylic adhesive tapes,
single and double sided

12

GD

Polysulphide, Polyurethane and
Butyl glass sealants

13

KÖRABOND

Cleaners and primers for
the adhesion improvement

14

KÖRASOLV

Solvents and cleaners for
surface preparation and dilution

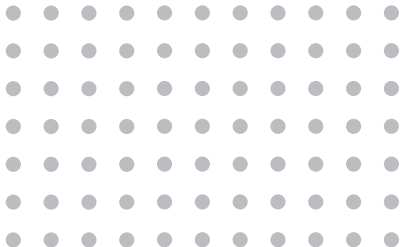



REFRIDGERATED VEHICLES

5 7

- Bonding of the skirting board with Körapur
- Floor coating with Körapur or Körapox

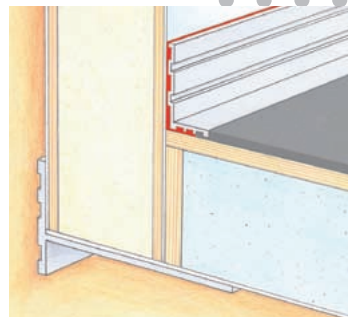

5 9 11

- Assembly bonding with Körapur or Körapop and Köratape as assembly help

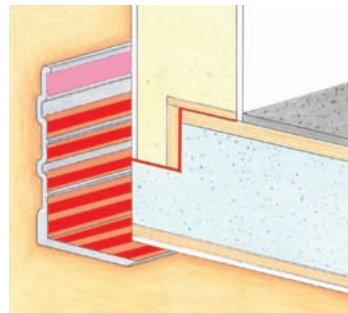

5 9

- Sealing of the roof element with Körapur or Körapop

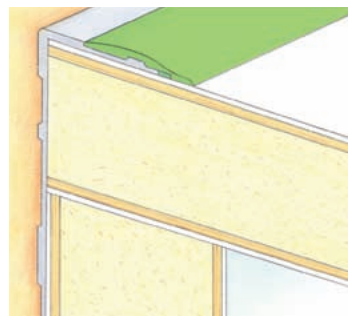

5

- Bonding of double floor case rails with Körapur

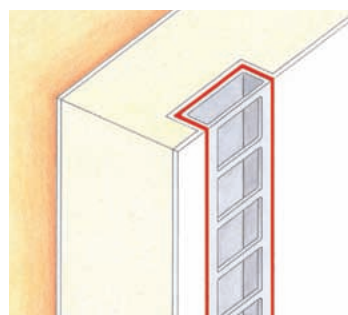

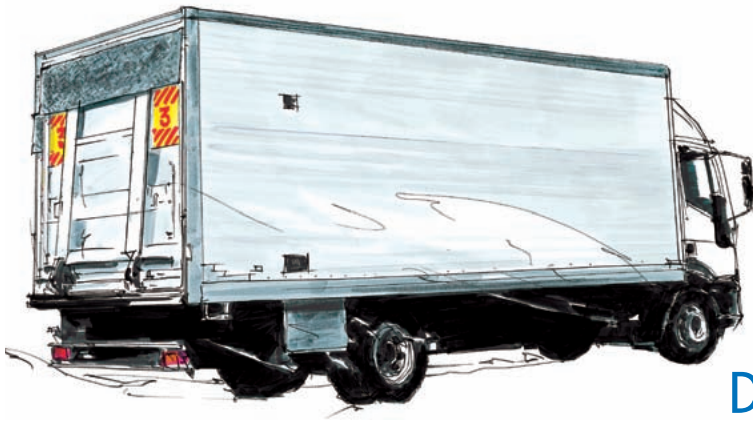

DRY FREIGHT VEHICLES

5

- Bonding of locking rails with Körapur one and two component

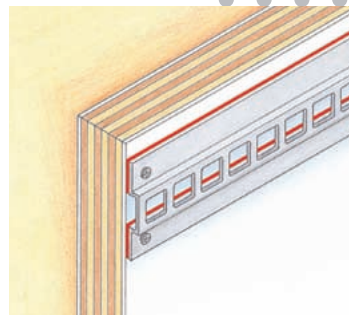

5

9

- Bonding and sealing of edge profiles and assembly of the corner joint with Körapur or Körapop

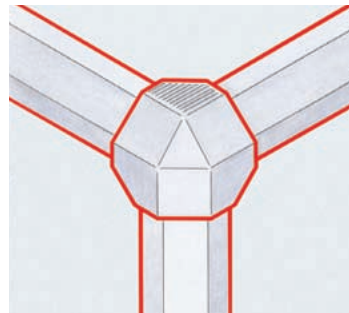

5

9

11

- Assembly of roof profiles with Körapop or Körapur
- Use Köratape as assembly help

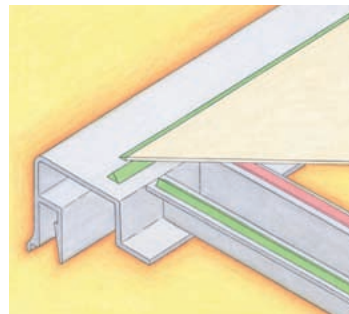

6

- Underlay riveted hat profiles with Ködiplast to seal against leaks and to reduce noise

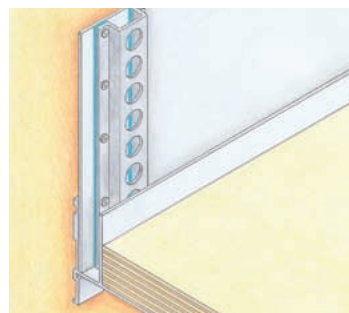



MOBILE HOMES

5

– Production of sandwich elements for sidewall, roof and floor with Körapur one and two component

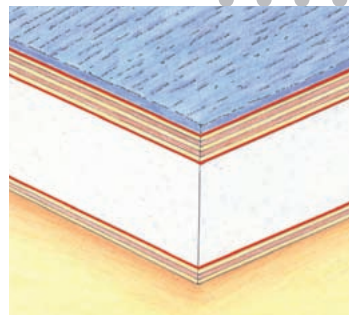

1

10

– Bonding of wall and floor coverings with Köracoll or Körapren



5

9

– Assembly bonding and sealing with Körapur and Körapop

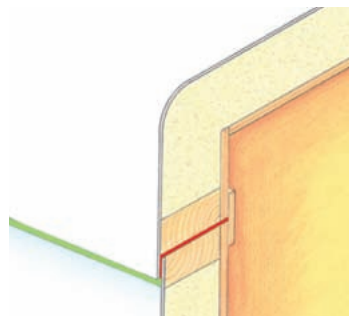

4

– Sealing and bonding in the sanitary area with Ködisil

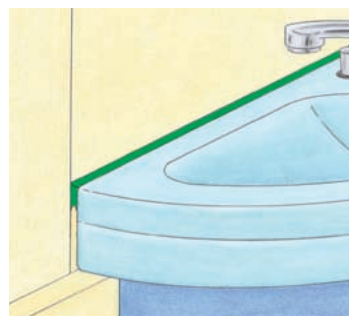



CARAVANS

5

9

– Bonding and sealing of thermoplastic trim parts with Körapur or Körapop

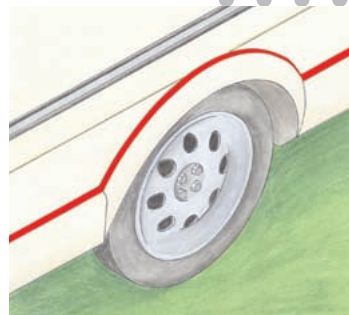

1

3

10

– Production of furniture facings with Köracoll, Köramelt or Körapren



8

– Bonding of rubber and PVC sealing profiles with Köratac

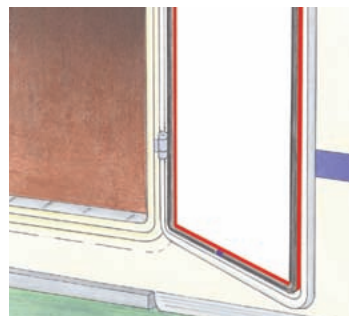

6

– Sealing of windows, overlapping areas, screw connections as well as floor joints with Ködiplast

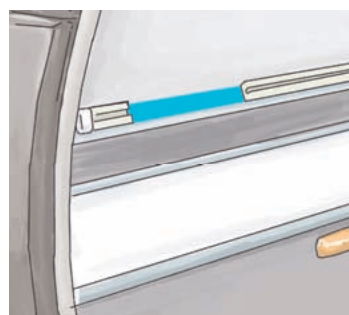

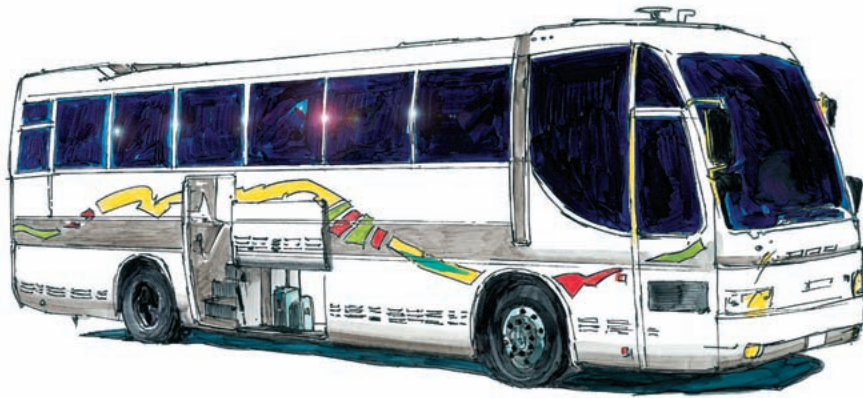

BUSES AND COACHES



- Sealing of weld seams with Körapop
- Bonding of side panels and base plates with Körapur or Körapop one and two component

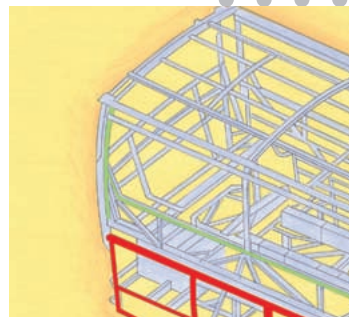

- Bonding and sealing of luggage compartment flaps and floor bonding with Körapur or Körapop



- Production and installation of interior trim with Köramelt, Köracoll or Körapren
- Sealing of edge covers with Ködisil or Körapur



- Sealing of various clamping profiles, cappings and overlaps with Ködiplast, Körapop or Körapur
- Bonding of stair coverings and stair edges with Körapren or Köraplast





MOBILE SALES VEHICLES

1 2 10

– Interior lining of the wall surfaces with Köracoll, Köraplast or Körapren

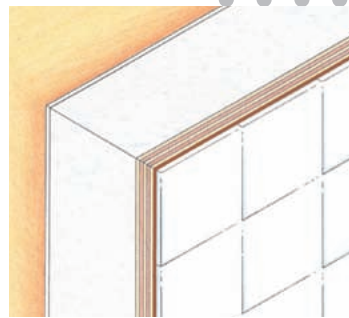

4 5

– Sealing in the interior areas with Ködisil or Körapur

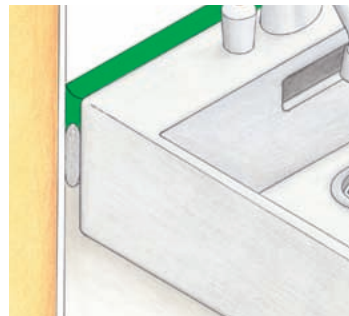

4

– Bonding and sealing of glass counters with Ködisil or Köditec

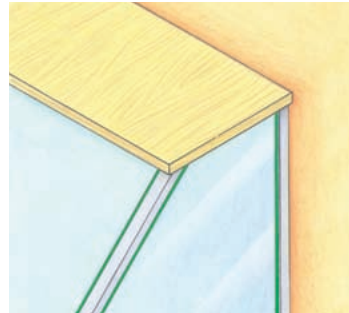

5 7

– Coating of floor and sidewall with Körapur or Körapox

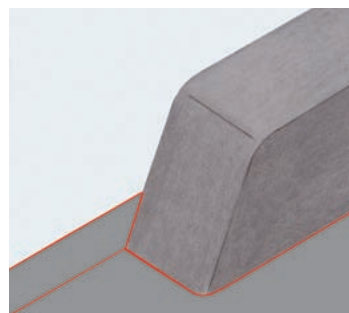



RAIL-MOUNTED VEHICLES

5

- Bonding of the GRP vehicle head to the body with Körapur one and two component

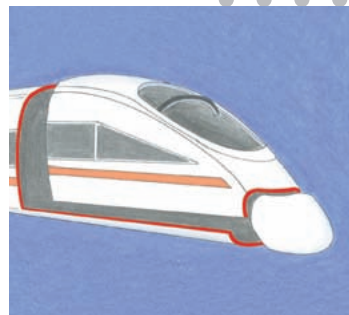

9

- Sealing between the body and insulating glass element with Körapop one and two component

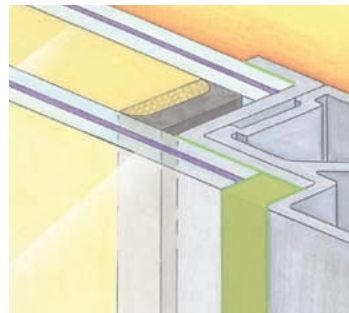

5

9

- Bonding of the floor element and sealing with Körapur or Körapop

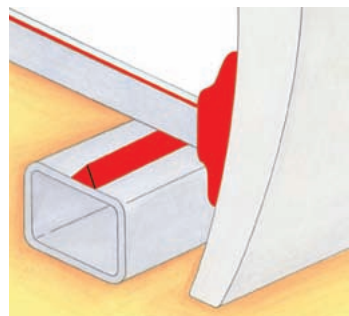

12

- Production of the sound proof insulating glass elements with GD, the glass sealants based on polysulphide, polyurethane and butyl

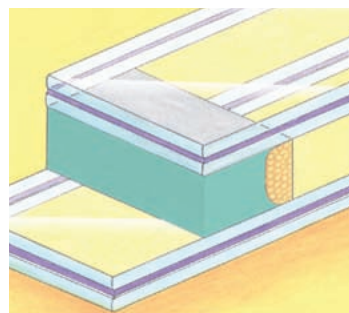

SANDWICH AND ASSEMBLY BONDING

Side wall element in insulating construction

Core composite element from PS-, pure foam or PVC-rigid foam with surface layers from GRP, aluminium, steel or VA panel and wooden inlays bonded with Körapur one and two component adhesives.

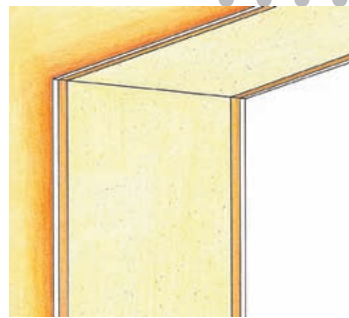

Floor element in adhesive technology

Bonding of aluminium sheet (galvanised), plywood and rigid insulating foam with Körapur one and two component adhesives.

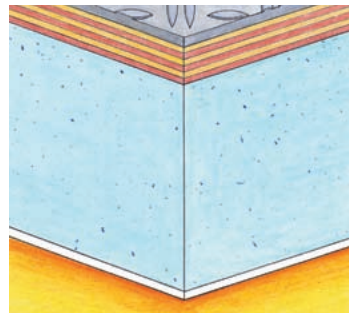

Construction of coated floor element

Floor coating on plywood with Körapur two component. Smooth and rough surfaces available with Körapox or Körapur.

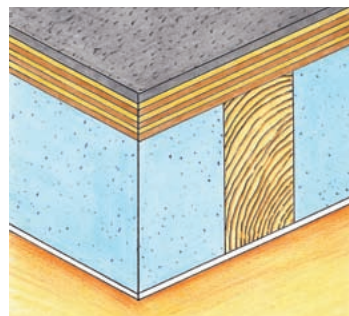

Assembly bonding

Bonding of plywood side wall and screen printed floor panels into the profile with Körapur or Körapop one and two component. Seal against water penetration with Körapur or Körapop.

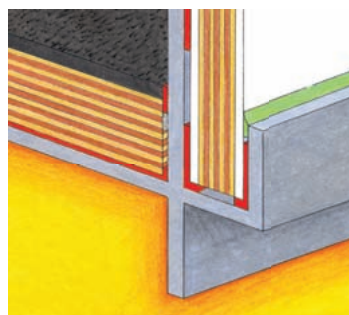

KÖMMERLING – MORE THAN JUST A PRODUCT

Our philosophy ...

... more research and development!

We have the solutions for tomorrow's requirements today.

... more products!

We have the widest product-range in the market.

... more logistics!

We help to save your time.

... more consulting and training!

We increase your benefit, your certainty and your income return.

... more service!

We are there when you need us.

... more communication!

We are active in building-up your market.

... more quality!

We offer you high performance products.

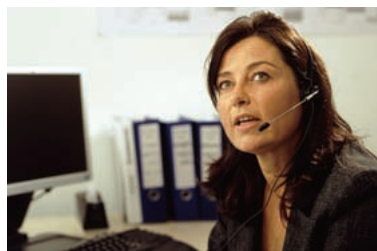
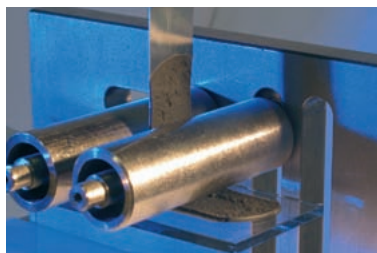

KÖMMERLING

KÖMMERLING CHEMISCHE FABRIK GMBH

**National
Seal Systems
Limited**

Unit 210 Holly Road, Western Ind. Estate, Naas Road, Dublin 12.
Ph 01-4565170 Fx 014502371 Email info@nationalseal.ie
Web: www.nationalseal.ie