

EXIDOR

DOOR CONTROLS

ARCHITECTURAL DOOR CONTROLS & ACCESSORIES

**National
Seal Systems
Limited**

*Unit 210 Holly Road, Western Industrial Estate,
Naas Road, Dublin 12
Ph 00353-1-4565170 Fax 00353-1-4502371
Email: info@nationalseal.ie web: www.nationalseal.ie*



What's inside

06 STANDARD CLOSERS

- 06 4000 Series
- 08 9000 Series
- 10 5000 Series
- 11 Superior Plus

12 E-MAGS

- 12 4000 Series
- 13 9000 Series
- 14 Superior Plus
- 15 Concealed & Slimline
- 16 3000 Series Floor Spring
- 17 Ultimate Transom

18 CONCEALED & SLIMLINE CLOSERS

19 FLOOR SPRINGS

- 19 2000 Series
- 20 Floor Pivots
- 21 900 Series

22 ULTIMATE TRANSOM CLOSER

23 ACCESSORIES

- 23 Overhead Door Closers
- 24 Floor Springs
- 25 Ultimate Transom and Concealed & Slimline Closers

26 REGULATIONS

Guarantee

To support the high quality and first class engineering that has gone into the Exidor Door Controls range, the manufacturer gives a ten year guarantee for mechanical components, and a two year guarantee for electrical components (subject to conditions) against defects due to faulty manufacturing, workmanship or defective material. The manufacturer agrees to replace any defective Exidor product free of charge provided the product has been fitted in accordance with the fitting instructions and maintained correctly.

Technical Support

Comprehensive information and technical support services are available by contacting:



Unit 210 Holly Road, Western Industrial Estate,
Naas Road, Dublin 12
Ph 00353-1-4565170 Fax: 00353-1-4502371
Email: info@nationalseal.ie web: www.nationalseal.ie

There are a number of enhancements we've made to the Exidor website. You'll also find new company info, technical data, and downloadable pdf's of the latest product literature – all presented in a clear and contemporary style that we hope you'll enjoy.

We're aiming to keep on improving the website, with more new specifiers on the way, and additions to our gallery of products and projects. If you have comments and ideas on ways we can make it even better and more useful, just let us know.





Introducing Exidor Door Controls

Exidor Ltd is a UK based engineering company manufacturing a comprehensive, high specification range of innovative panic and emergency hardware, door controls and builders ironmongery.

Range

The Exidor Door Controls offer a choice of suited product ranges, from a size 2/3 selectable, to the 2-5 adjustable with backcheck and delayed action options. Hold open arms are an optional accessory, and a choice of high efficiency slide arm closers are also available.

A comprehensive selection of E-mags completes the overhead door closer series.

Exidor also offers a choice of floor springs, from the adjustable power size 1-4, through to the heavy duty power size 1-6 range, which can be used on doors up to 600KG.

Transom closers and the newly introduced concealed and slimline ranges complete Exidor's comprehensive offering.

Cam and Roller

The Exidor overhead door closer range features the unique high efficiency cam and roller action which is ideal for use where the Equality Act 2010 (formerly the DDA) and BS8300 – Approved Document "M" need to be considered.

The floor springs and transom closers use a double cam mechanism that not only gives class leading carrying capacity and efficiency, but provides excellent centring at the zero position in the double action version.

This is achieved by using an additional cam, which is not subject to the same wear as the main cam, to provide an accurate return to the zero position, regardless of the number of cycles in either direction which the closer has performed.

The shape of the curve

The cam and roller or double cam mechanism 'gears' the action of the door closer to provide the optimum opening and closing forces where they are needed – as the door is near the frame. The rapidly falling opening force makes the door easier to open, whilst an increasing closing force as the door nears the frame on the closing cycle, ensures safe, secure closing.



Efficiency

Efficiency is expressed by describing the closing force as a percentage of the opening force. Therefore a 20 Newtons closing force and 27 Newtons opening force would give an efficiency of: $20 \div 27 \times 100 = 74\%$

The greater the efficiency, the easier it is to open the door. Exidor's cam and roller mechanism, with precision engineered parts and unique bearings, result in very highly efficient door closers.

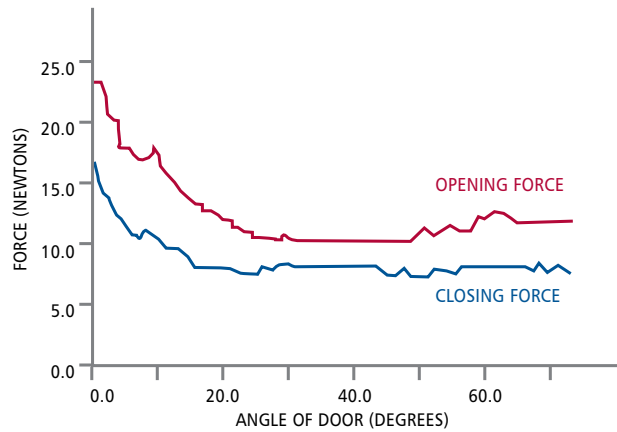

EN 1154 DOOR WEIGHT & RECOMMENDED WIDTH		
Power size of closer	Max weight of hinged leaf (KG)	Width of test leaf
1	20	750mm
2	40	850mm
3	60	950mm
4	80	1100mm
5	100	1250mm
6	120	1400mm
7	160	1600mm

EN 1155 DOOR WEIGHT & RECOMMENDED WIDTH		
Hold open power size	Max weight of hinged leaf (KG)	Width of test leaf
3	60	950mm
4	80	1100mm
5	100	1250mm
6	120	1400mm
7	160	1600mm

FLOOR SPRING WEIGHT/DOOR WIDTH RECOMMENDATIONS		
Max door width	Max door weight (KG)	Exidor floor spring Ref No.
1100mm	400	2000 Series
1400mm	600	900 Series

Construction

The door closer body is made from extruded aluminium, which gives the best starting point for bore roundness for the piston to operate with high efficiency and a long working life.

The pinion bearings are made from composite material which reduce the friction in operation and provide remarkable durability.

The combination of materials, construction and design innovation of the cam and roller mechanism give outstanding results in use. One key element is that when using a door closer on the "push" side of the door, significant power loss is usually experienced. Exidor door closers do not lose any power in this application, and furthermore are "CERTIFIRE" approved for use in fig 61 and fig 66.

What does British manufacturing mean to us?

Understanding what our customers need. Providing local and reliable service. Having a wide range of standard units available from stock for fast delivery. Being able to provide non-standard products. Reacting quickly when it matters. Working to international quality and manufacturing standards and certified to ISO 9001:2008. And caring – professionally – about quality.

Ordering information

When ordering please clearly state the following to assist us in meeting your requirements:

- Model Number
- Description
- Finish
- Quantity

ORDERING DOOR CLOSERS:

The exact model code can be determined by specifying code numbers for series, size, function and arm from the key below:

SERIES	
4000 Series	4
5000 Series	5
9000 Series	9

SIZE	
1 and 4 (dual power)	0
2/3 selectable	7
3/4 selectable	8
2-5 adjustable	9

FUNCTION	
Standard	0
Delayed action	1
Magnetic hold open	2
Backcheck	3
Backcheck and delayed action	4
E-mag hold open/swing free	7

ARM	
Universal	0
Slide arm	3
Hold open	5

For example the ordering code for a 9000 series door closer (9), size 2-5 adjustable (9) with backcheck function (3) and standard arm (0) is 9930:

9	9	3	0
SERIES	SIZE	FUNCTION	ARM

When ordering the 4000 series please state which slide design is required 'E', 'L' or 'B'. Please see page 12 for options.

ORDERING FLOOR SPRINGS:

The exact model code can be determined by specifying code numbers for series, size, function and hold from the key below:

SERIES	
2000 Series	2
3000 Series	3

SIZE	
4	4
1-4 adjustable	9

FUNCTION	
Backcheck	5
Backcheck and delayed action	6
Electro-magnetic hold open	7

HOLD	
Non-hold open	0
Mechanical hold open	2

For example the ordering code for a 2000 series floor spring (2), size 1-4 adjustable (9) with backcheck function (5) and mechanical hold open (2) is 2952:

2	9	5	2
SERIES	SIZE	FUNCTION	HOLD

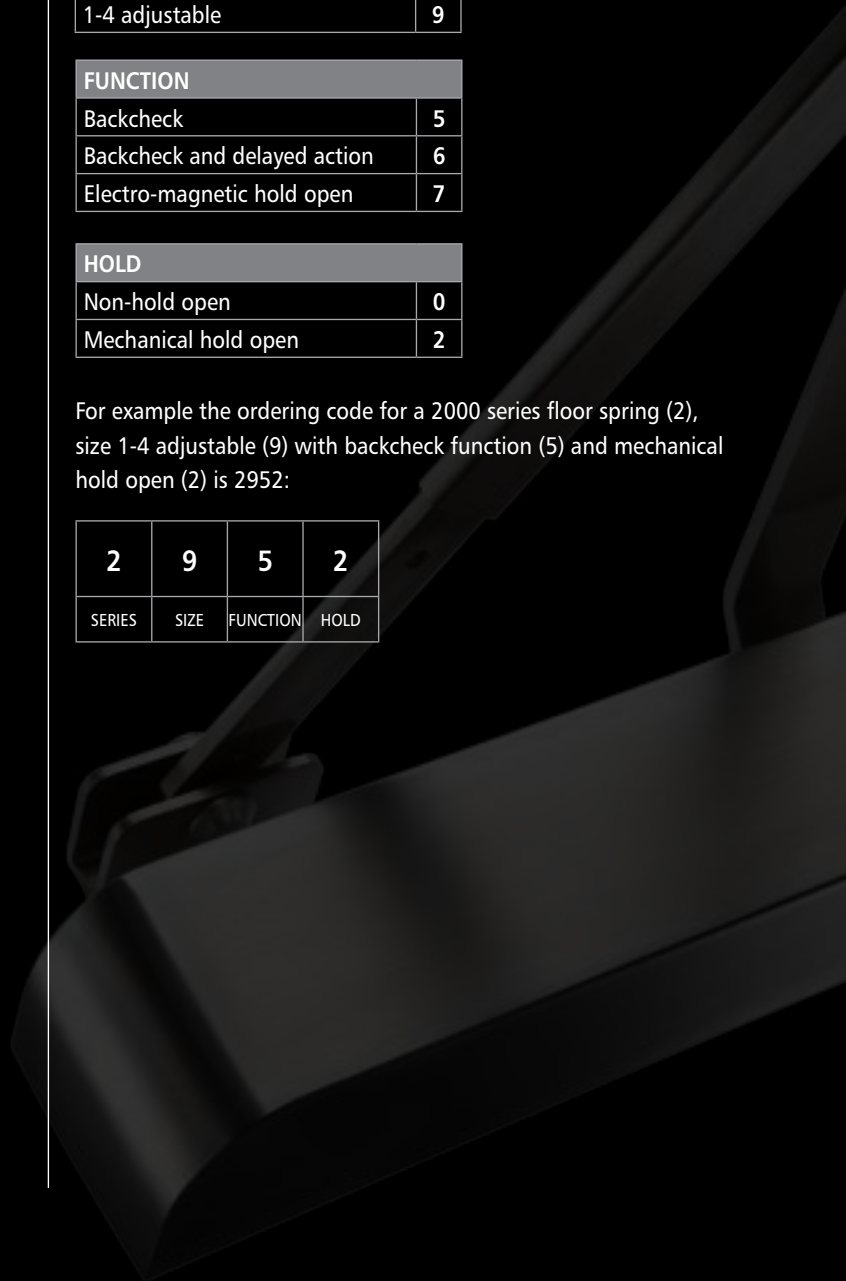

4000 Series Overhead Door Closer

OVERHEAD DOOR CLOSERS WITH MATCHING ARM, AVAILABLE WITH A CHOICE OF 3 DIFFERENT SLIDE COVERS

BS EN 1154



The Exidor 4000 overhead door closer range offers a choice of three closers, each available with the option of three different slides. All closers offer the unique high efficiency cam and roller action making them suitable where the Equality Act is a consideration. The selectable power size 2/3 and 3/4 are offered with the option of backcheck, whereas the adjustable power size 2-5 offers a choice of standard, backcheck, delayed action or backcheck with delayed action. Alternatively there is the selectable power size 2/3/4 which offers magnetic hold open. The magnetic hold open is activated at any angle above 70° up to a maximum of 165° and the door simply stays in position. The hold open is disengaged by a slight pull on the door.

All closers are supplied as standard with a matching arm, and there is also the option of having a hold open arm. All Exidor closers offer universal fitting and are supplied with brackets for fig 1, fig 61 and fig 66 fixing.



4900 E-slide



B-slide



L-slide

		4700	4730	4800	4830	4900	4930	4910	4940	4820
Closing Force	EN Size	2/3	2/3	3/4	3/4	2-5	2-5	2-5	2-5	2/3/4
Door Size (Max)	Width (mm)	950	950	1100	1100	1250	1250	1250	1250	1100
	Weight (KG)	60	60	80	80	100	100	100	100	80
Application	Fig 1	✓	✓	✓	✓	✓	✓	✓	✓	✓
	Fig 6	✓	✓	✓	✓	✓	✓	✓	✓	✓
	Fig 66	✓	✓	✓	✓	✓	✓	✓	✓	✓
Mechanism	Rack & Pinion	X	X	X	X	X	X	X	X	X
	Cam & Roller	✓	✓	✓	✓	✓	✓	✓	✓	✓
With Cover		X	X	X	X	X	X	X	X	X
Power Shoe Bracket		✓	✓	✓	✓	✓	✓	✓	✓	✓
Angle of Opening		180°	180°	180°	180°	180°	180°	180°	180°	180°
Non Handed		✓	✓	✓	✓	✓	✓	✓	✓	✓
Power Adjustment	By Spring	X	X	X	X	✓	✓	✓	✓	X
	By Template	✓	✓	✓	✓	X	X	X	X	✓
Adjustable Sweep Speed		✓	✓	✓	✓	✓	✓	✓	✓	✓
Adjustable Latching Speed		✓	✓	✓	✓	✓	✓	✓	✓	✓
Adjustable Backcheck		X	✓	X	✓	X	✓	X	✓	X
Adjustable Delayed Action		X	X	X	X	X	X	✓	✓	X
Magnetic Hold Open		X	X	X	X	X	X	X	X	✓
CE Marked		X	X	✓	✓	✓	✓	X	X	X
Certifire Approved		X	X	✓	✓	✓	✓	X	X	N/A
Guarantee		10 yrs	10 yrs	10 yrs	10 yrs	10 yrs	10 yrs	10 yrs	10 yrs	10 yrs
OPTIONS										
Slide Covers	E	✓	✓	✓	✓	✓	✓	✓	✓	✓
	B	✓	✓	✓	✓	✓	✓	✓	✓	✓
	L	✓	✓	✓	✓	✓	✓	✓	✓	✓
Cover	Radius	X	X	X	X	X	X	X	X	X
	Square	X	X	X	X	X	X	X	X	X
Hold Open Arm		✓	✓	✓	✓	✓	✓	✓	✓	✓
Finishes		Silver, RAL, PAA, SAA, PB, SS, PS								

End plates

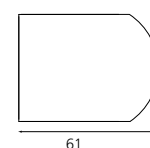

61

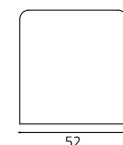

52

Dimensions (measurements in millimetres):

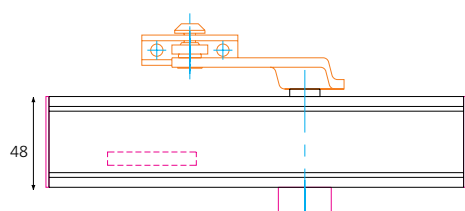

221/263

Standard 4800/4820

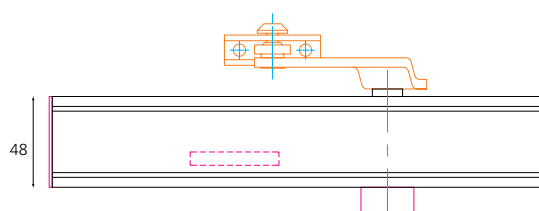

269

4900 Series

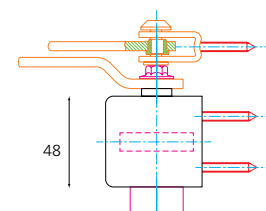

52

4000 Series Slide Arm Door Closer

OVERHEAD DOOR CLOSERS WITH MATCHING SLIDE ARM & CHANNEL, AVAILABLE WITH A CHOICE OF 3 DIFFERENT SLIDE COVERS

The Exidor 4000 series slide arm door closer range offers the choice of three different slide covers, and all closers incorporate the unique high efficiency cam and roller action, which is particularly suited to this type of closer.

With adjustable power size 2-4 there is a choice of standard, backcheck, delayed action or backcheck with delayed action. The slide arm offers a greater resistance to vandalism as the arm and channel are far less obtrusive than standard scissor arms.

All closers are supplied as standard with a matching arm, and there is also an option of having a hold open in the track. All Exidor closers offer universal fitting and are supplied with brackets for fig 1, fig 61 and fig 66 fixing.



4900 B-slide



L-slide



E-slide

End plates

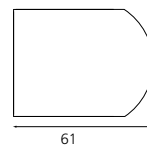

61



52

		4903	4933	4913	4943
Closing Force	EN Size	2-4	2-4	2-4	2-4
Door Size (Max)	Width (mm)	1100	1100	1100	1100
	Weight (KG)	80	80	80	80
Application	Fig 1	✓	✓	✓	✓
	Fig 6	✓	✓	✓	✓
	Fig 66	✓	✓	✓	✓
Mechanism	Rack & Pinion	X	X	X	X
	Cam & Roller	✓	✓	✓	✓
With Cover		X	X	X	X
Power Shoe Bracket		✓	✓	✓	✓
Angle of Opening		105°	105°	105°	105°
Non Handed		✓	✓	✓	✓
Power Adjustment	By Spring	✓	✓	✓	✓
	By Template	X	X	X	X
Adjustable Sweep Speed		✓	✓	✓	✓
Adjustable Latching Speed		✓	✓	✓	✓
Adjustable Backcheck		X	✓	X	✓
Adjustable Delayed Action		X	X	✓	✓
CE Marked		X	X	X	X
Certifire Approved		X	X	X	X
Guarantee		10 yrs	10 yrs	10 yrs	10 yrs
OPTIONS					
Slide Covers	E	✓	✓	✓	✓
	B	✓	✓	✓	✓
	L	✓	✓	✓	✓
External Hold Open		✓	✓	✓	✓
Cover	Radius	X	X	X	X
	Square	X	X	X	X
Finishes		Silver, RAL, PAA, SAA, PB, SS, PS			

Dimensions (measurements in millimetres):

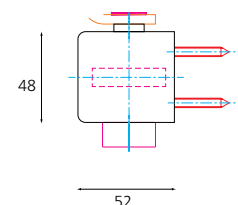
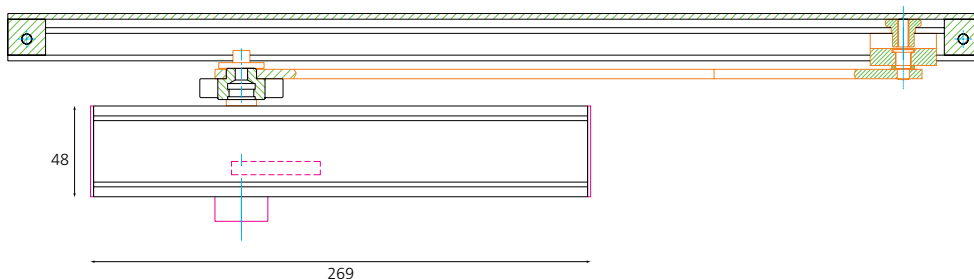

9000 Series Overhead Door Closer

OVERHEAD DOOR CLOSERS WITH COVER & MATCHING ADJUSTABLE ARM

The Exidor 9000 overhead door closer range offers a choice of two closers, each available with either a radius or square cover, all with the unique high efficiency cam and roller action making them suitable where the Equality Act is a consideration. The selectable power size 3/4 offers the option of backcheck, whereas the adjustable power size 2-5 has a choice of standard, backcheck, delayed action or backcheck with delayed action. Alternatively there is the selectable power size 2/3/4 which offers magnetic hold open. The magnetic hold open is activated at any angle above 70° up to a maximum of 165°, and the door simply stays in position. The hold open is disengaged by a slight pull on the door.

All closers are supplied as standard with a matching adjustable arm, and there is also the option of having a hold open arm. All Exidor closers come with universal fitting and are supplied with brackets for fig 1, fig 61 and fig 66 fixing.

BS EN 1154



Radius cover



Square cover

		9800	9830	9900	9930	9910	9940	9820
Closing Force	EN Size	3/4	3/4	2-5	2-5	2-5	2-5	2/3/4
Door Size (Max)	Width (mm)	1100	1100	1250	1250	1250	1250	1100
	Weight (KG)	80	80	100	100	100	100	80
Application	Fig 1	✓	✓	✓	✓	✓	✓	✓
	Fig 6	✓	✓	✓	✓	✓	✓	✓
	Fig 66	✓	✓	✓	✓	✓	✓	✓
Mechanism	Rack & Pinion	X	X	X	X	X	X	X
	Cam & Roller	✓	✓	✓	✓	✓	✓	✓
With Cover		✓	✓	✓	✓	✓	✓	✓
Power Shoe Bracket		✓	✓	✓	✓	✓	✓	✓
Angle of Opening		180°	180°	180°	180°	180°	180°	180°
Non Handed		✓	✓	✓	✓	✓	✓	✓
Power Adjustment	By Spring	X	X	✓	✓	✓	✓	X
	By Template	✓	✓	X	X	X	X	✓
Adjustable Sweep Speed		✓	✓	✓	✓	✓	✓	✓
Adjustable Latching Speed		✓	✓	✓	✓	✓	✓	✓
Adjustable Backcheck		X	✓	X	✓	X	✓	X
Adjustable Delayed Action		X	X	X	X	✓	✓	X
Magnetic Hold Open		X	X	X	X	X	X	✓
CE Marked		✓	✓	✓	✓	X	X	X
Certifire Approved		✓	✓	✓	✓	X	X	N/A
Guarantee		10 yrs	10 yrs	10 yrs	10 yrs	10 yrs	10 yrs	10 yrs
OPTIONS								
Slide Covers	E	X	X	X	X	X	X	X
	B	X	X	X	X	X	X	X
	L	X	X	X	X	X	X	X
Hold Open Arm		✓	✓	✓	✓	✓	✓	X
Cover	Radius	✓	✓	✓	✓	✓	✓	✓
	Square	✓	✓	✓	✓	✓	✓	✓
Finishes		Silver, RAL, SS, PS, PB						

Dimensions (measurements in millimetres):

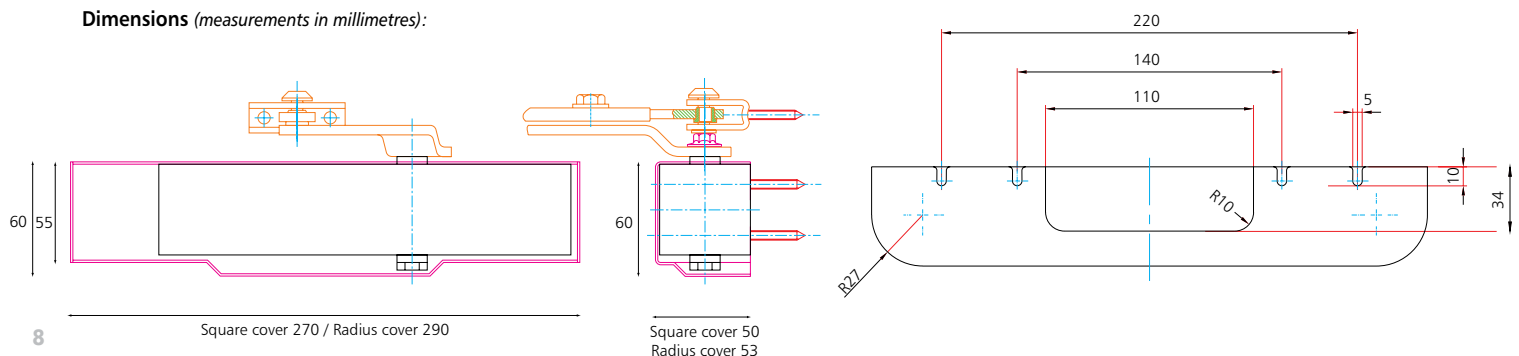

Square cover 270 / Radius cover 290

Square cover 50
Radius cover 53

9000 Series Slide Arm Door Closer

OVERHEAD DOOR CLOSERS WITH COVER AND MATCHING SLIDE ARM & CHANNEL

The Exidor 9000 series slide arm door closer range offers the choice of either a radius or square cover, each with the unique high efficiency cam and roller action which is particularly suited to this type of closer. With adjustable power size 2-4 there is a choice of standard, backcheck, delayed action or backcheck with delayed action. The slide arm offers a greater resistance to vandalism as the arm and channel are far less obtrusive than standard scissor arms.

All closers are supplied as standard with a matching arm and channel, and there is also an option of having a hold open in the track. All Exidor closers offer universal fitting and are supplied with brackets for fig 1, fig 61 and fig 66 fixing.



Radius cover



Square cover

		9903	9933	9913	9943
Closing Force	EN Size	2-4	2-4	2-4	2-4
Door Size (Max)	Width (mm)	1100	1100	1100	1100
	Weight (KG)	80	80	80	80
Application	Fig 1	✓	✓	✓	✓
	Fig 6	✓	✓	✓	✓
	Fig 66	✓	✓	✓	✓
Mechanism	Rack & Pinion	X	X	X	X
	Cam & Roller	✓	✓	✓	✓
With Cover		✓	✓	✓	✓
Power Shoe Bracket		✓	✓	✓	✓
Angle of Opening		105°	105°	105°	105°
Non Handed		✓	✓	✓	✓
Power Adjustment	By Spring	✓	✓	✓	✓
	By Template	X	X	X	X
Adjustable Sweep Speed		✓	✓	✓	✓
Adjustable Latching Speed		✓	✓	✓	✓
Adjustable Backcheck		X	✓	X	✓
Adjustable Delayed Action		X	X	✓	✓
CE Marked		X	X	X	X
Certifire Approved		X	X	X	X
Guarantee		10 yrs	10 yrs	10 yrs	10 yrs
OPTIONS					
Slide Covers	E	X	X	X	X
	B	X	X	X	X
	L	X	X	X	X
External Hold Open		✓	✓	✓	✓
Cover	Radius	✓	✓	✓	✓
	Square	✓	✓	✓	✓
Finishes		Silver, RAL, SS, PS, PB			

Dimensions (measurements in millimetres):

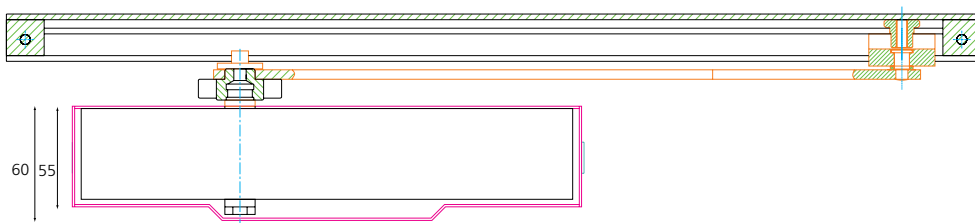

Square cover 270 / Radius cover 290

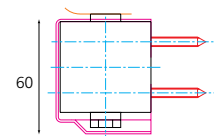

Square cover 50
Radius cover 53

5000 Series Overhead Door Closer

OVERHEAD DOOR CLOSERS WITH MATCHING ARM

The Exidor 5000 overhead door closer range offers a choice of either selectable power size 2/3 or 3/4. Each closer is supplied with the unique high efficiency cam and roller action which is particularly suited where the Equality Act is a consideration. A matching arm and a solid painted body are supplied as standard.

All Exidor closers offer universal fitting and come with brackets for fig 1, fig 61 and fig 66 fixing.

BS EN 1154



		5700	5800
Closing Force	EN Size	2/3	3/4
Door Size (Max)	Width (mm)	950	1100
	Weight (KG)	60	80
Application	Fig 1	✓	✓
	Fig 6	✓	✓
	Fig 66	✓	✓
Mechanism	Rack & Pinion	X	X
	Cam & Roller	✓	✓
With Cover		X	X
Power Shoe Bracket		✓	✓
Angle of Opening		180°	180°
Non Handed		✓	✓
Power Adjustment	By Spring	X	X
	By Template	✓	✓
Adjustable Sweep Speed		✓	✓
Adjustable Latching Speed		✓	✓
Adjustable Backcheck		X	X
Adjustable Delayed Action		X	X
Magnetic Hold Open		X	X
CE Marked		X	✓
Certifire Approved		X	✓
Guarantee		10 yrs	10 yrs
OPTIONS			
Slide Covers	E	X	X
	B	X	X
	L	X	X
Hold Open Arm		✓	✓
Cover	Radius	X	X
	Square	X	X
Finishes	Silver, Gold, RAL		

Dimensions (measurements in millimetres):

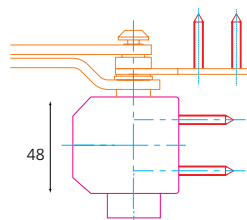
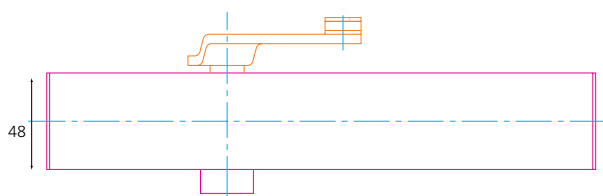

Superior Plus Overhead Door Closer

OVERHEAD DOOR CLOSERS WITH MATCHING ARM

The Exidor Superior Plus overhead door closers are an aesthetically pleasing range using a rack and pinion action. There is a choice of 2 closers, each available as standard or capless. The adjustable power size 2-4 and adjustable power size 2-5 offer a choice of fig 1 and fig 6 fixing positions, each with the option of backcheck, backcheck and delayed action or hold open. The hold open is disengaged by a slight pull on the door.

All closers are supplied as standard with a matching arm, and there is also the option of a hold open model.



		SP001	SP041	SP006	SP046	SP001/ HO	SP006/ HO	SP101	SP141	SP106	SP146	SP101/ HO	SP106/ HO
Closing Force	EN Size	2-4	2-4	2-4	2-4	2-4	2-4	2-5	2-5	2-5	2-5	2-5	2-5
Door Size (Max)	Width (mm)	1100	1100	1100	1100	1100	1100	1250	1250	1250	1250	1250	1250
	Weight (KG)	80	80	80	80	80	80	100	100	100	100	100	100
Application	Fig 1	✓	✓	X	X	✓	X	✓	✓	X	X	✓	X
	Fig 6	X	X	✓	✓	X	✓	X	X	✓	✓	X	✓
	Fig 66	X	X	✓	✓	X	✓	X	X	✓	✓	X	✓
Mechanism	Rack & Pinion	✓	✓	✓	✓	✓	✓	✓	✓	✓	✓	✓	✓
	Cam & Roller	X	X	X	X	X	X	X	X	X	X	X	X
Capless		✓	✓	✓	✓	✓	✓	X	X	X	X	X	X
Power Shoe Bracket		✓	✓	✓	✓	✓	✓	✓	✓	✓	✓	✓	✓
Angle of Opening		180°	180°	180°	180°	180°	180°	180°	180°	180°	180°	180°	180°
Non Handed		✓	✓	✓	✓	✓	✓	✓	✓	✓	✓	✓	✓
Power Adjustment	By Spring	✓	✓	✓	✓	✓	✓	✓	✓	✓	✓	✓	✓
	By Template	X	X	X	X	X	X	X	X	X	X	X	X
Adjustable Sweep Speed		✓	✓	✓	✓	✓	✓	✓	✓	✓	✓	✓	✓
Adjustable Latching Speed		✓	✓	✓	✓	✓	✓	✓	✓	✓	✓	✓	✓
Adjustable Backcheck		✓	✓	✓	✓	X	X	✓	✓	✓	✓	X	X
Adjustable Delayed Action		X	✓	X	✓	X	X	X	✓	X	✓	X	X
Hold Open		X	X	X	X	✓	✓	X	X	X	X	✓	✓
CE Marked		X	X	X	X	X	X	X	X	X	X	X	X
Certifire Approved		X	X	X	X	X	X	X	X	X	X	X	X
Guarantee		10 yrs	10 yrs	10 yrs	10 yrs	10 yrs	10 yrs	10 yrs	10 yrs	10 yrs	10 yrs	10 yrs	10 yrs
OPTIONS													
Slide Covers	E	X	X	X	X	X	X	X	X	X	X	X	X
	B	X	X	X	X	X	X	X	X	X	X	X	X
	L	X	X	X	X	X	X	X	X	X	X	X	X
Cover	Radius	X	X	X	X	X	X	X	X	X	X	X	X
	Square	X	X	X	X	X	X	X	X	X	X	X	X
Finishes		PB, SS, PS, PAA											

Dimensions (measurements in millimetres):

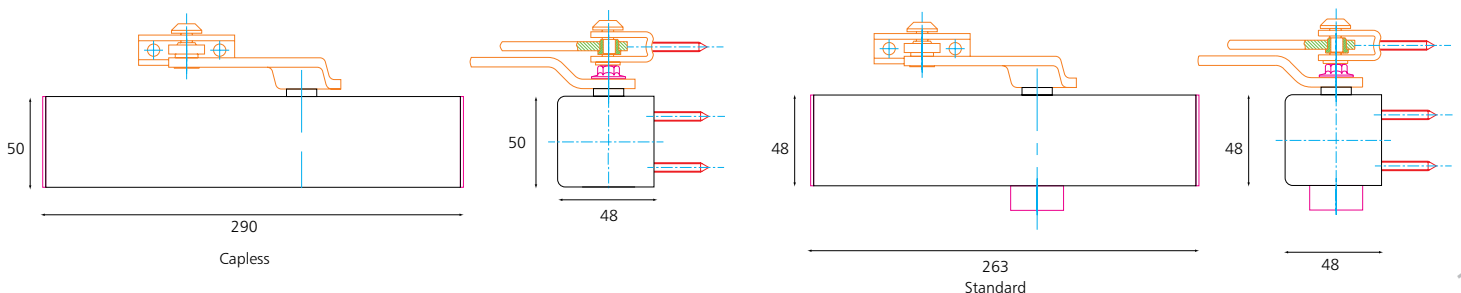

4000 Series E-mag Closer

ELECTRO-MAGNETIC DOOR CLOSERS WITH MATCHING ADJUSTABLE ARM, AVAILABLE WITH A CHOICE OF 3 DIFFERENT SLIDE COVERS

BS EN 1155



The Exidor 4000 series E-mag range is suitable for use where low opening forces are required, such as care homes, hospitals or where the Equality Act is a consideration. There are two closers within the range, one offering a hold open fixed power size 4 which, when fitted in swing free mode, allows the door to be opened with no resistance from the closer. However, when the buildings fire alarm is activated, power is cut to the unit and the closer then shuts the door. The other is a dual power closer that, when fitted, operates in power size 1, allowing the door to be opened by a force of under 22N. However, when the buildings fire alarm is activated, power is cut to the unit, and the closer then becomes a power size 4 and is able to shut the door.

All the Exidor 4000 Series of E-mags are supplied with an adaptor which allows easy conversion from hold open to swing free mode.

Both options offer the choice of three different slide covers, each with a matching adjustable arm and the unique cam and roller action, and both have a plug in power loop for ease of fitting. Longer power loops are available as an optional extra. All Exidor closers offer universal fitting and are supplied with brackets for fig 1, fig 61 and fig 66 fixing.

E-MAG



4870 B slide

		4870	4070
Closing Force	EN Size	4	1 & 4
Door Size (Max)	Width (mm)	1100	1100
	Weight (KG)	80	80
Application	Fig 1	✓	✓
	Fig 6	✓	✓
	Fig 66	✓	✓
Mechanism	Rack & Pinion	X	X
	Cam & Roller	✓	✓
With Cover		X	X
Power Shoe Bracket		✓	✓
Angle of Opening		180°	180°
Non Handed		✓	✓
Power Adjustment	By Spring	X	X
	By Template	X	X
Adjustable Sweep Speed		✓	✓
Adjustable Latching Speed		✓	✓
Adjustable Backcheck		X	X
Adjustable Delayed Action		X	X
Dual Power		X	✓
CE Marked		✓	X
Certifire Approved		✓	X
Guarantee		2 yrs	2 yrs
OPTIONS			
Slide Covers	E	✓	✓
	B	✓	✓
	L	✓	✓
Cover	Radius	X	X
	Square	X	X
Extended Loop	650mm	✓	✓
Finishes	Silver, RAL, PAA, SAA, SS, PS, PB		

End plates

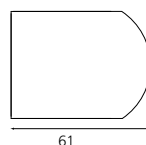

61

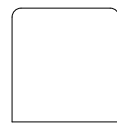

52



L-slide



E-slide

Dimensions (measurements in millimetres):

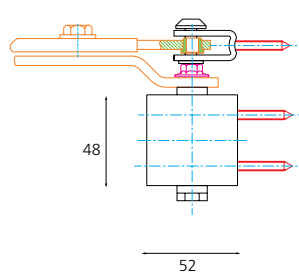
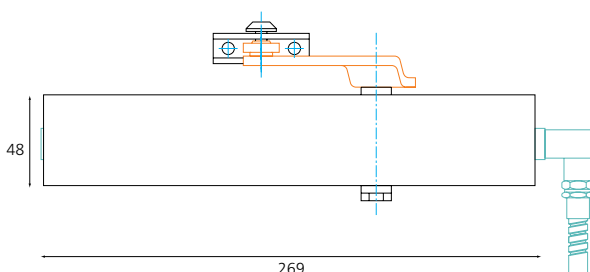

9000 Series E-mag Closer

ELECTRO-HYDRAULIC DOOR CLOSERS WITH COVER & MATCHING ADJUSTABLE ARM

BS EN 1155



The Exidor 9000 series E-mag range is suitable for use where low opening forces are required, such as care homes, hospitals or where the Equality Act is a consideration. There are two closers within the range, one offering a hold open fixed power size 4 which, when fitted in swing free mode, allows the door to be opened with no resistance from the closer. However, when the buildings fire alarm is activated, power is cut to the unit and the closer then shuts the door. The other is a dual power closer that, when fitted, operates in power size 1, allowing the door to be opened by a force of under 22N. However, when the buildings fire alarm is activated, power is cut to the unit and the closer then becomes a power size 4 and is able to shut the door.

All the Exidor 9000 Series of E-mags are supplied with an adaptor which allows easy conversion from hold open to swing free mode.

Both options offer the choice of either a radius or square cover with matching adjustable arms, each utilising the unique high efficiency cam and roller action, and both have a plug in power loop for ease of fitting. Longer power loops are available as an optional extra. All Exidor closers offer universal fitting and are supplied with brackets for fig 1, fig 61 and fig 66 fixing.

		9870	9070
Closing Force	EN Size	4	1 & 4
Door Size (Max)	Width (mm)	1100	1100
	Weight (KG)	80	80
Application	Fig 1	✓	✓
	Fig 6	✓	✓
	Fig 66	✓	✓
Mechanism	Rack & Pinion	X	X
	Cam & Roller	✓	✓
With Cover		✓	✓
Power Shoe Bracket		✓	✓
Angle of Opening		180°	180°
Non Handed		✓	✓
Power Adjustment	By Spring	X	X
	By Template	X	X
Adjustable Sweep Speed		✓	✓
Adjustable Latching Speed		✓	✓
Adjustable Backcheck		X	X
Adjustable Delayed Action		X	X
Dual Power		X	✓
CE Marked		✓	X
Certifire Approved		✓	X
Guarantee		2 yrs	2 yrs
OPTIONS			
Slide Covers	E	X	X
	B	X	X
	L	X	X
Cover	Radius	✓	✓
	Square	✓	✓
Extended Loop	650mm	✓	✓
Finishes	Silver, RAL, SS, PS, PB		

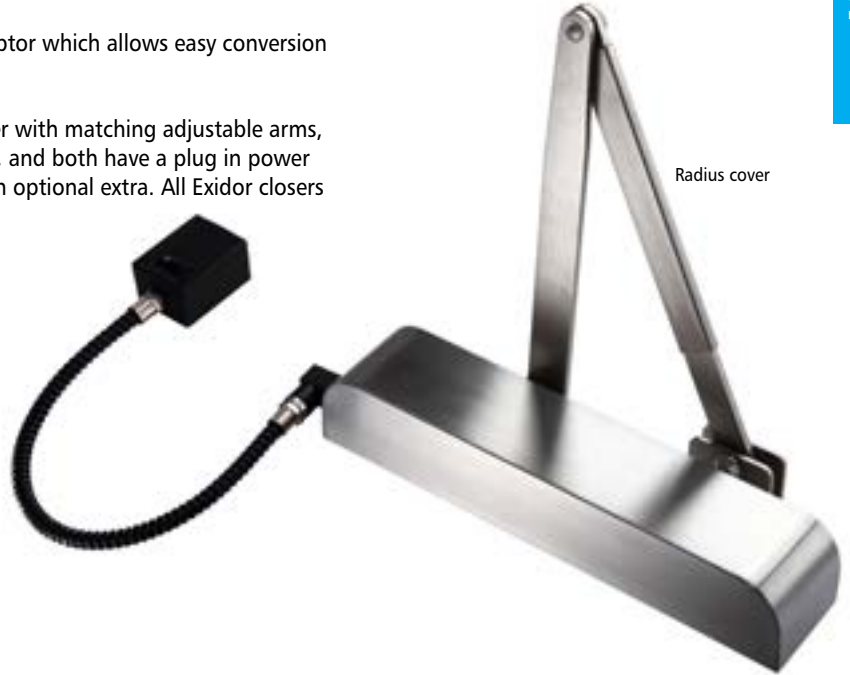

Radius cover



Square cover

Dimensions (measurements in millimetres):

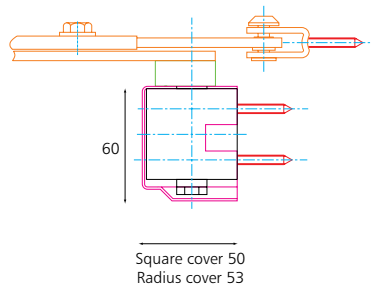
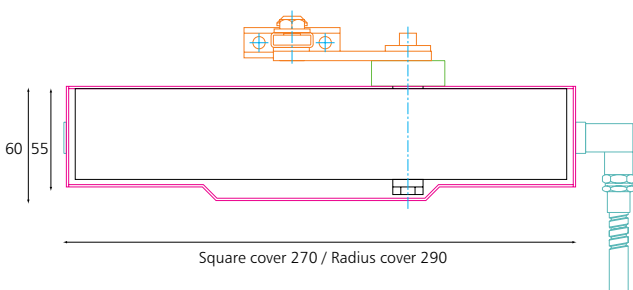

E-MAG

Superior Plus Series E-mag Closer

ELECTRO-MAGNETIC DOOR CLOSERS WITH MATCHING ARM

The Exidor Superior Plus E-mags are an aesthetically pleasing range with a rack and pinion action for use where low opening forces are required, such as care homes, hospitals or where the Equality Act is a consideration. There are four closers in the range, two for use in fig 1 application and two for use where fig 6 application is required.

There is also a swing free option, which allows the door to be opened with no resistance from the closer. However, when the buildings fire alarm is activated, power is cut to the unit and the closer then shuts the door. All closers are offered as standard with a matching arm.



E-MAG

		SP271	SP276	SP371	SP376
Closing Force	EN Size	3	3	3	3
Door Size (Max)	Width (mm)	950	950	950	950
	Weight (KG)	60	60	60	60
Application	Fig 1	✓	✗	✓	✗
	Fig 6	✗	✓	✗	✓
	Fig 66	✗	✓	✗	✓
Mechanism	Rack & Pinion	✓	✓	✓	✓
	Cam & Roller	✗	✗	✗	✗
With Cover		✗	✗	✗	✗
Power Shoe Bracket		✓	✓	✓	✓
Angle of Opening		180°	180°	180°	180°
Non Handed		✓	✓	✓	✓
Power Adjustment	By Spring	✗	✗	✗	✗
	By Template	✗	✗	✗	✗
Adjustable Sweep Speed		✓	✓	✓	✓
Adjustable Latching Speed		✓	✓	✓	✓
Adjustable Backcheck		✗	✗	✗	✗
Adjustable Delayed Action		✗	✗	✗	✗
Hold Open		✓	✓	✗	✗
Hold Open / Swing Free		✗	✗	✓	✓
Dual Power		✗	✗	✗	✗
CE Marked		✗	✗	✗	✗
Certifire Approved		✗	✗	✗	✗
Guarantee		2 yrs	2 yrs	2 yrs	2 yrs
OPTIONS					
Slide Covers	E	✗	✗	✗	✗
	B	✗	✗	✗	✗
	L	✗	✗	✗	✗
Cover	Radius	✗	✗	✗	✗
	Square	✗	✗	✗	✗
Finishes		PB, SS, PS, PAA			

Dimensions (measurements in millimetres):

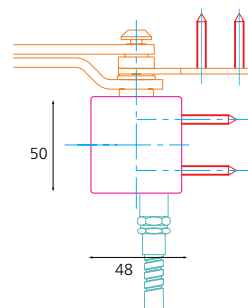
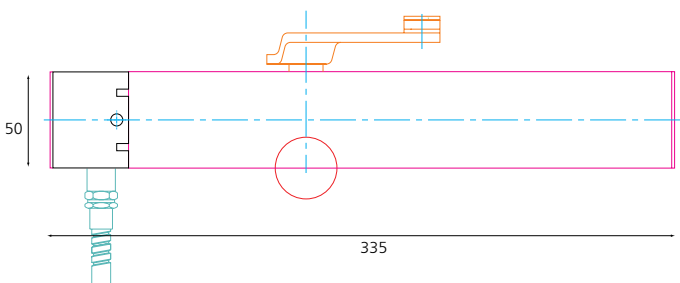

6000 Series E-mag Concealed & Slimline

WITH MATCHING SLIDE ARM & CHANNEL

BS EN 1155



The Exidor 6000 series slimline/concealed E-mag range is suitable for use where low opening forces are required, such as care homes, hospitals or where the Equality Act is a consideration. The range offers an adjustable power size 2-4, and also a hold open option which allows the door to be opened with little resistance from the closer. However, when the buildings fire alarm is activated, power is cut to the closer, and the unit then shuts the door.

The Exidor 6000 series slimline/concealed range offers two cam action closers, one which is concealed within the door and the other is a slimline overhead door closer. The concealed version is particularly suited where discreet door control is required, or where there is a high risk of vandalism, and is available with a double action option. Other optional extras include backcheck and hold open functions.

E-MAG

		6870	6970
Concealed		✓	✗
Slimline with Cover		✗	✓
Closing Force	EN Size	2-4	2-4
Door Size (Max)	Width (mm)	1100	1100
	Weight (KG)	80	80
Application	Fig 1	✓	✓
	Fig 6	✓	✓
	Fig 66	✓	✓
Mechanism	Rack & Pinion	✗	✗
	Cam Action	✓	✓
Angle of Opening		120°	120°
Non Handed		✓	✓
Power Adjustment	By Spring	✓	✓
	By Template	✗	✗
Adjustable Sweep Speed		✓	✓
Adjustable Latching Speed		✓	✓
Cover	Radius	✗	✗
	Square	✗	✓
CE Marked		✓	✓
Certifire Approved		✓	✓
Guarantee		2 yrs	2 yrs
OPTIONS			
Retro Fit Channel and Arm		✗	✗
Double Action		✓	✗
Backcheck in the Channel		✓	✓
Hold Open in the Channel		✓	✓
Finishes	Silver, RAL, PB, SS, PS		



Slimline



Concealed

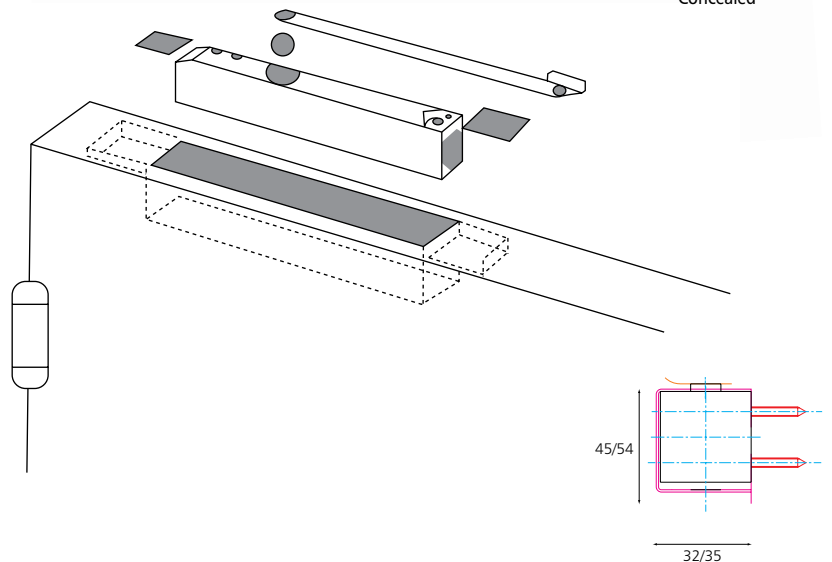

Dimensions (measurements in millimetres):

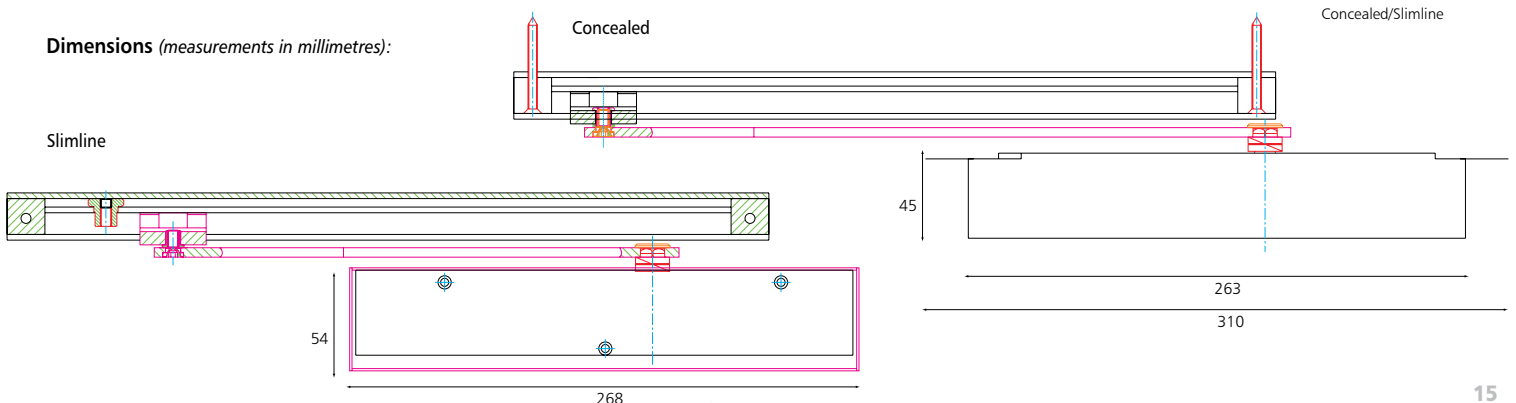

3000 Series E-mag Floor Spring

FLOOR SPRING COMPLETE WITH FITTINGS

BS EN 1155



The Exidor 3000 series E-mag floor spring fits discreetly into the floor, giving better resistance to interference and vandalism and is suitable for use where low opening forces are required, such as care homes, hospitals or where the Equality Act is a consideration. It is a fixed power size 4 which, when fitted, is in hold open/swing free mode, allowing the door to be opened with no resistance from the floor spring. However, when the buildings fire alarm is activated, power is cut to the floor spring and the unit then closes the door.

Available in both single and double action, the floor spring can be supplied complete, or mechanism only when being used as a replacement.

Optional extras include extra height spindles, 200° cam and gel infill for improved water resistance. The cover plate is available in a choice of three plated finishes.

E-MAG



		3470
Closing Force	EN Size	4
Door Size (Max)	Width (mm)	1100
	Weight (KG)	400
Mechanism	Rack & Pinion	X
	Double Cam	✓
Angle of Opening		180°
Non Handed		✓
Power Adjustment	By Spring	X
	By Template	X
Action Availability	Single	✓
	Double	✓
Adjustable Sweep Speed		✓
Backcheck		✓
Heavy Duty Backcheck		X
Adjustable Delayed Action		X
Hold Open	80° - 180°	✓
CE Marked		✓
Certifire Approved		✓
Guarantee		2 yrs
OPTIONS		
Single Action Accessories		✓
Double Action Accessories		✓
Spindle Extensions		✓
200° Cam for single action doors requiring controlled closing from 180°		✓
Gel Infill For Improved Water Resistance		✓
Mechanism & Box Only		✓
Finishes	SS, PS, PB	

Cover plates

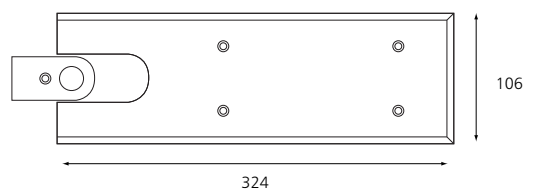

Dimensions (measurements in millimetres):

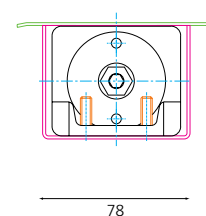
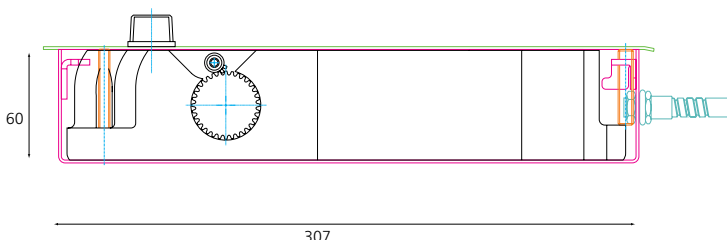

1000 Series E-mag Ultimate Transom Closer

ULTIMATE TRANSOM CLOSERS COMPLETE WITH ARM SET & BOTTOM PIVOT

BS EN 1155



The Exidor E-mag Ultimate transom closer offers a neat, aesthetically pleasing way to control door opening. They are particularly popular where a discreet closer is required, and are widely used in hospitals, universities and public buildings. Suitable for both internal and external doors, the closer can be used with aluminium, timber and hollow metal doors and frames, and comes with an adjustable floor pivot.

It is a fixed power size 4 which allows the door to be opened with little resistance from the closer. However, when the buildings fire alarm is activated, power is cut to the unit and the closer then shuts the door. Available in double action, the transom closer can be supplied complete, or mechanism only when being used as a replacement. Optional extras include end load arm and extra height floor pivot.



E-MAG

		1470
Closing Force	EN Size	4
Door Size (Max)	Width (mm)	1100
	Weight (KG)	600
Mechanism	Rack & Pinion	X
	Cam Action	✓
Angle of Opening		180°
Non Handed		✓
Power Adjustment	By Spring	X
	By Template	X
Side Load Arm		✓
Action	Single	X
	Double	✓
Adjustable Sweep Speed		✓
Latching Speed		✓
Backcheck		✓
Adjustable Delayed Action		X
Hold Open	80° - 180°	✓
CE Marked		✓
Certifire Approved		✓
Guarantee		2 yrs
OPTIONS		
Short Side Load Arm		✓
End Load Arm		✓
Spindle Extensions		✓
Intumescent Pack		✓
Mechanism Only		✓
Finishes	SS, PS, PB	

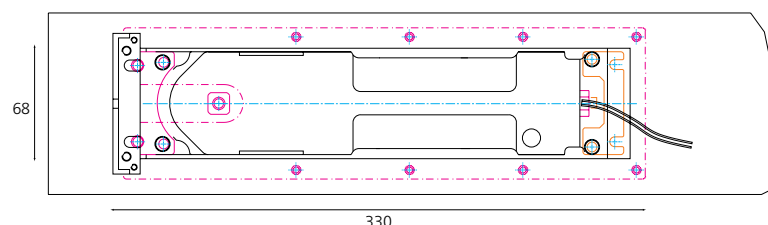
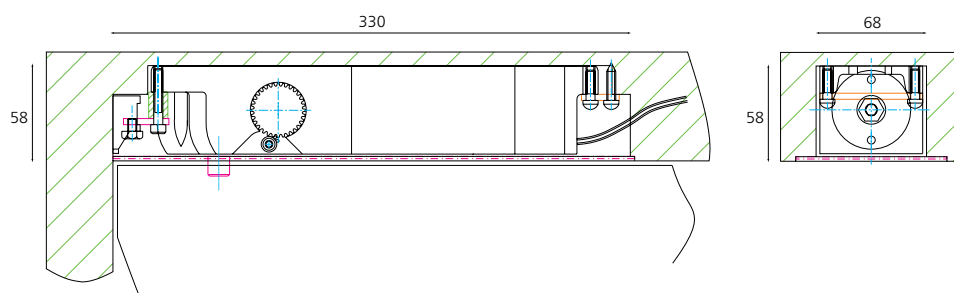

Dimensions (measurements in millimetres):

6000 Series Concealed & Slimline Closer

WITH MATCHING SLIDE ARM & CHANNEL

BS EN 1154



The Exidor 6000 series concealed and slimline range offers two closers, one which is concealed within the door and the other that is a slimline overhead unit. The concealed version is particularly suitable for use where discreet door control is preferred, or where there is a high risk of vandalism. The concealed unit also has a retro fit option which offers easier fitting as it does not require the door frame to be cut out to accommodate the slide arm track.

Both closers offer adjustable power size 2-4, and both come as standard with adjustable sweep and latching speed. Backcheck and hold open versions are available and there is also a choice of five finishes. The 6800 concealed range is also available with a double action option.

CONCEALED



Slimline



Concealed



Concealed retro fit

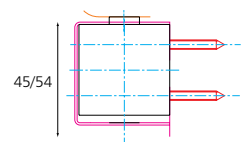
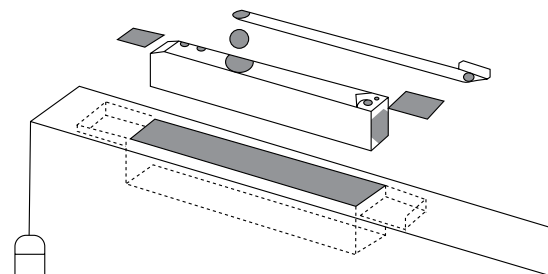

Concealed/Slimline

		6800	6805	6830	6900	6905	6930
Concealed		✓	✓	✓	✗	✗	✗
Slimline with Cover		✗	✗	✗	✓	✓	✓
Closing Force	EN Size	2-4	2-4	2-4	2-4	2-4	2-4
Door Size (Max)	Width (mm)	1100	1100	1100	1100	1100	1100
	Weight (KG)	80	80	80	80	80	80
Application	Fig 1	✓	✓	✓	✓	✓	✓
	Fig 6	✓	✓	✓	✓	✓	✓
	Fig 66	✓	✓	✓	✓	✓	✓
Mechanism	Rack & Pinion	✗	✗	✗	✗	✗	✗
	Cam Action	✓	✓	✓	✓	✓	✓
Angle of Opening		120°	120°	120°	120°	120°	120°
Non Handed		✓	✓	✓	✓	✓	✓
Power Adjustment	By Spring	✓	✓	✓	✓	✓	✓
	By Template	✗	✗	✗	✗	✗	✗
Adjustable Sweep Speed		✓	✓	✓	✓	✓	✓
Adjustable Latching Speed		✓	✓	✓	✓	✓	✓
Backcheck		✗	✗	✓	✗	✗	✓
Hold Open		✗	✓	✗	✗	✓	✗
CE Marked		✓	✗	✓	✓	✗	✓
Certifire Approved		✓	✗	✓	✓	✗	✓
Guarantee		10 yrs	10 yrs	10 yrs	10 yrs	10 yrs	10 yrs
OPTIONS							
Retro Fit Channel and Arm		✓	✗	✗	✗	✗	✗
Double Action		✓	✓	✓	✗	✗	✗
Cover	Radius	✗	✗	✗	✗	✗	✗
	Square	✗	✗	✗	✓	✓	✓
Finishes		Silver, RAL, PB, SS, PS					

Dimensions (measurements in millimetres):

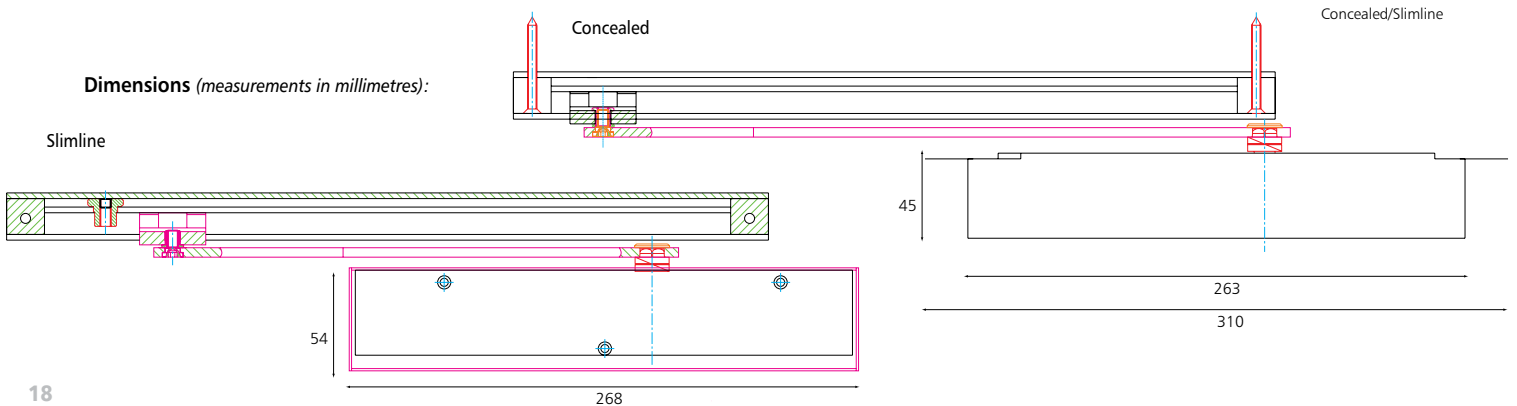

2000 Series Floor Spring

FLOOR SPRING WITH BACKCHECK

BS EN 1154



The Exidor 2000 series double cam mechanism floor spring range fit discreetly into the floor, giving improved resistance to interference and vandalism, and are particularly suited to shops, offices, hospitals etc. Available in both single and double action with backcheck, they feature adjustable power size 1-4, can be used for doors up to 400KG and are available as a complete unit, or as a mechanism only where replacements are required.

Options include hold open and delayed action, and other accessories consist of extra height spindles, 200° cam and gel infill for improved water resistance. The cover plate is available in a choice of three plated finishes.



FLOOR SPRING

		2950	2952	2960
Closing Force	EN Size	1-4	1-4	1-4
Door Size (Max)	Width (mm)	1100	1100	1100
	Weight (KG)	400	400	400
Mechanism	Rack & Pinion	X	X	X
	Double Cam	✓	✓	✓
Angle of Opening		180°	180°	180°
Non Handed		✓	✓	✓
Power Adjustment	By Spring	✓	✓	✓
	By Template	X	X	X
Action Availability	Single	✓	✓	✓
	Double	✓	✓	✓
Adjustable Sweep Speed		✓	✓	✓
Latching Speed		✓	✓	✓
Backcheck		✓	✓	✓
Heavy Duty Backcheck		X	X	X
Delayed Action		X	X	✓
Hold Open		X	✓	X
CE Marked		✓	✓	✓
Certifire Approved		✓	X	X
Guarantee		10 yrs	10 yrs	10 yrs
OPTIONS				
Single Action Accessories		✓	✓	✓
Double Action Accessories		✓	✓	✓
Spindle Extensions		✓	✓	✓
200° Cam for single action doors requiring controlled closing from 180°		✓	✓	✓
Gel Infill For Improved Water Resistance		✓	✓	✓
Mechanism & Box Only		✓	✓	✓
Finishes	SS, PS, PB			

Dimensions (measurements in millimetres):

Cover plates

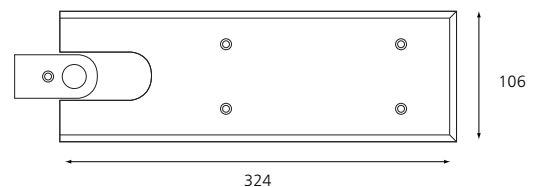

307

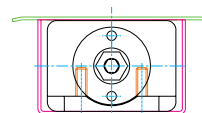

78

2000/4F Floor Pivot



The Exidor 2000/4F floor pivot uses the same class leading bearing technology as the floor spring and is used in applications where there is no requirement for closing a door, and using hinges is difficult because the door is heavy or a double action is required.

The 2000/4F can carry a door up to 400KG whilst having a very small footprint, and only has a recess below the floor surface of 15mm. The range is compatible with all Exidor floor spring strap systems and top centres, which must be ordered separately, if required.

Different height spindle extensions between 5mm and 50mm are available, but these must be ordered with the pivot as they cannot be changed on site.

The floor pivots are available in satin stainless steel, polished stainless steel or polished brass finish.



FLOOR PIVOT

		2000/4F
Closing Force	EN Size	N/A
Door Size (Max)	Width (mm)	1800
	Weight (KG)	400
Mechanism	Rack & Pinion	X
	Cam & Roller	X
Angle of Opening		N/A
Non Handed		✓
Power Adjustment	By Spring	X
	By Template	X
Action Availability	Single	✓
	Double	✓
Adjustable Sweep Speed		X
Adjustable Latching Speed		X
Adjustable Backcheck		X
Adjustable Delayed Action		X
Hold Open		X
CE Marked		X
Certifire Approved		✓
Guarantee		10 yrs
OPTIONS		
Single Action Accessories		X
Double Action Accessories		X
Spindle Extensions		✓
Finishes	SS, PS, PB	

Dimensions (measurements in millimetres):

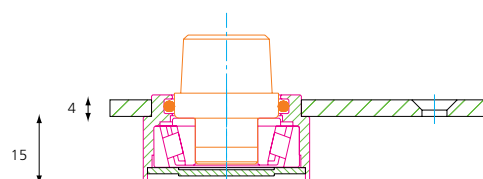
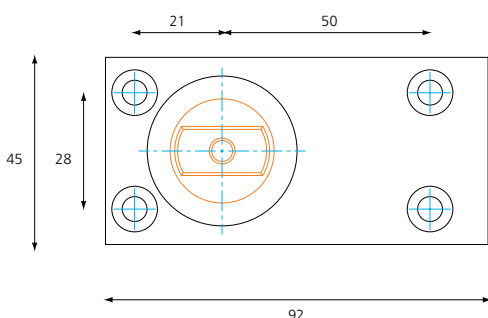

900 Series Floor Spring

HEAVY DUTY FLOOR SPRINGS WITH BACKCHECK

BS EN 1154



Generally considered the best in the market, the Exidor 900 series double cam mechanism floor spring range fits discreetly into the floor, giving improved resistance to interference and vandalism, and they are particularly suited to shops, offices, hospitals etc. Available in both single and double action with backcheck, they feature adjustable power size 1-6 and can be used for doors up to 600KG. Available as a complete unit, or as a mechanism only where replacements are required, the 900 series is equipped with a unique centre controlled closing mechanism which ensures smooth and quiet closing to the central closed position from either direction.

Options include 90°, 105° and 120° hold open, delayed action, and heavy duty backcheck for use on heavier doors. Other accessories consist of extra height spindles, 200° cam and gel infill for improved water resistance. The cover plate is available in a choice of three plated finishes.



		990	991	993	994	995
Closing Force	EN Size	1-6	1-6	1-6	1-6	1-6
Door Size (Max)	Width (mm)	1400	1400	1400	1400	1400
	Weight (KG)	600	600	600	600	600
Mechanism	Rack & Pinion	X	X	X	X	X
	Double Cam	✓	✓	✓	✓	✓
Angle of Opening		180°	180°	180°	180°	180°
Non Handed		✓	✓	✓	✓	✓
Power Adjustment	By Spring	✓	✓	✓	✓	✓
	By Template	X	X	X	X	X
Action Availability	Single	✓	✓	✓	✓	✓
	Double	✓	✓	✓	✓	✓
Adjustable Sweep Speed		✓	✓	✓	✓	✓
Latching Speed		✓	✓	✓	✓	✓
Backcheck		✓	✓	✓	✓	✓
Heavy Duty Backcheck		X	X	X	X	✓
Delayed Action		X	✓	X	X	X
Hold Open 90° & 120°		X	X	✓	X	X
Hold Open 105°		X	X	X	✓	X
CE Marked		✓	✓	✓	✓	✓
Certifire Approved		✓	X	X	X	X
Guarantee		10 yrs	10 yrs	10 yrs	10 yrs	10 yrs
OPTIONS						
Single Action Accessories		✓	✓	✓	✓	✓
Double Action Accessories		✓	✓	✓	✓	✓
Spindle Extensions		✓	✓	✓	✓	✓
200° Cam		✓	✓	✓	✓	✓
Gel Infill For Improved Water Resistance		✓	✓	✓	✓	✓
Mechanism & Box Only		✓	✓	✓	✓	✓
Finishes	SS, PS, PB					



FLOOR SPRING

Cover plates

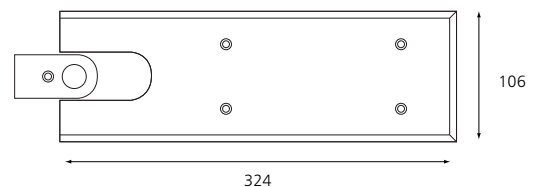

Dimensions (measurements in millimetres):

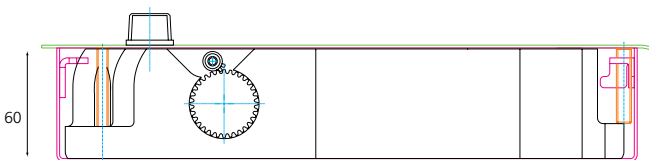

307

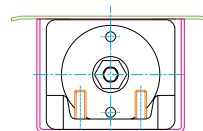

78

1000 Series Ultimate Transom Closer

ULTIMATE TRANSOM CLOSER COMPLETE WITH ARM SET & BOTTOM PIVOT

BS EN 1154



The Exidor Ultimate transom closer range offers a neat, aesthetically pleasing way to control a door opening. They are particularly popular where a discreet closer is required, and are widely used in hospitals, universities etc. Suitable for use on both internal and external doors, the unit can be used with aluminium, timber and hollow metal doors and frames, and comes with an adjustable floor pivot.

Available only in double action with adjustable power size 1-6, the transom closer can be supplied complete with fittings, or as mechanism only when being used as a replacement. Optional extras include extra height floor pivot, end load arm and intumescent packs.



		1950	1960	1952
Closing Force	EN Size	1-6	1-6	1-6
Door Size (Max)	Width (mm)	1100	1100	1100
	Weight (KG)	600	600	600
Mechanism	Rack & Pinion	X	X	X
	Double Cam	✓	✓	✓
Angle of Opening		180°	180°	180°
Non Handed		✓	✓	✓
Power Adjustment	By Spring	✓	✓	✓
	By Template	X	X	X
Side Load Arm		✓	✓	✓
Action	Single	X	X	X
	Double	✓	✓	✓
Adjustable Sweep Speed		✓	✓	✓
Latching Speed		✓	✓	✓
Backcheck		✓	✓	✓
Delayed Action		X	✓	X
Hold Open		X	X	✓
CE Marked		✓	✓	✓
Certifire Approved		✓	X	X
Guarantee		10 yrs	10 yrs	10 yrs
OPTIONS				
Short Side Load Arm		✓	✓	✓
End Load Arm		✓	✓	✓
Spindle Extensions		✓	✓	✓
Intumescent Pack		✓	✓	✓
Mechanism Only		✓	✓	✓
Finishes	SS, PS, PB			

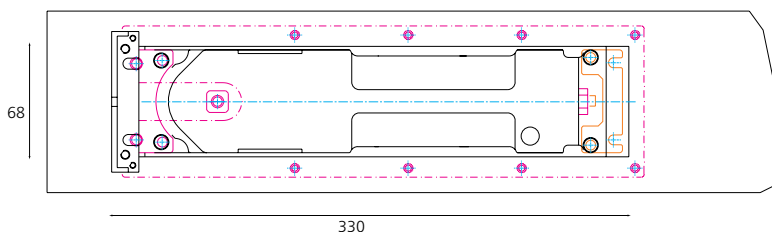

Dimensions (measurements in millimetres):

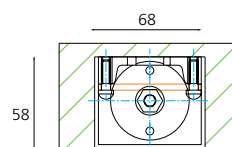
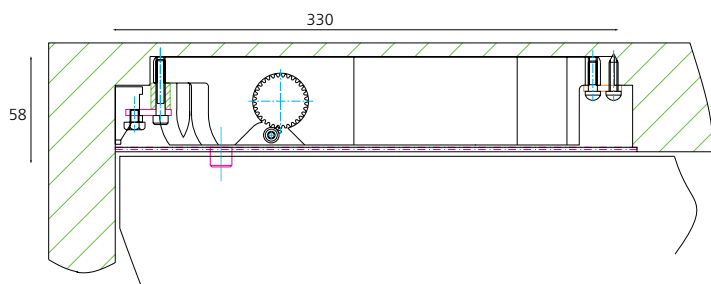

Door Closer Accessories

Overhead Door Closers

CODE	DESCRIPTION	SUITABILITY	FINISH
X034	Face fixing bracket for fig 1 and fig 61 applications. Supplied as standard with projecting arm models.	Standard & E-mag	Silver, RAL, SS, PS & PB
X016	Soffit plate for fig 1, fig 61 and fig 66 applications. Supplied as standard with projecting arm models	Standard & E-mag	Silver, RAL, SS, PS & PB
X038	Soffit plate with intumescent protection for fig 1, fig 61 and fig 66 applications. For use on timber fire doors in frames with moulded architraves.	Standard & E-mag	Silver, RAL, SS, PS & PB
X040	Drop plate for fig 1 application.	All	Silver, RAL, SS, PS & PB
X041	Drop plate for fig 6 application.	All	Silver, RAL, SS, PS & PB
X042	Saddle bracket for glass doors.	All	Silver, RAL, SS, PS & PB
X043	Bolt through bracket for glass doors.	All	Silver, RAL, SS, PS & PB
X001	Fixed projecting arm. Supplied as standard with the 4000, 5000 and Superior Plus ranges.	Standard only	Silver, RAL, SS, PS & PB
X002	Adjustable projecting arm. Supplied as standard with the 9000 series.	Standard only	Silver, RAL, SS, PS & PB
X003	Hold open projecting arm.	Standard & E-mag	Silver, RAL, SS, PS & PB
X004	E-mag projecting adjustable arm. Supplied as standard with the E-mag ranges.	E-mag only	Silver, RAL, SS, PS & PB
X005	Slide arm & Channel. Supplied as standard with the 4000 and 9000 slide arm ranges.	Slide arm only	Silver, RAL, SS, PS & PB
X020	B Slide cover.	4000 series only	Silver, RAL, PAA, SAA, SS, PS & PB
X021	E Slide cover.	4000 series only	Silver, RAL, PAA, SAA, SS, PS & PB
X022	L Slide cover.	4000 series only	Silver, RAL, PAA, SAA, SS, PS & PB
X023	End caps for B slide.	4000 series only (Excl E-mags)	Silver, RAL, PAA, SAA, SS, PS & PB
X024	End caps for E or L slide.	4000 series only (Excl E-mags)	Silver, RAL, PAA, SAA, SS, PS & PB
X025	End caps for B slide E-mags.	4000 series E-mags only	Silver, RAL, PAA, SAA, SS, PS & PB
X026	End caps for E or L slide E-mags.	4000 series E-mags only	Silver, RAL, PAA, SAA, SS, PS & PB
X027	Spindle cap.	4000 series	Silver, RAL, PAA, SAA, SS, PS & PB
X030	Square cover.	9000 series (Excl E-mags)	Silver, RAL, PAA, SAA, SS, PS & PB
X031	Radius cover.	9000 series (Excl E-mags)	Silver, RAL, PAA, SAA, SS, PS & PB
X032	Square cover - E-mags	9000 series E-mags only	Silver, RAL, PAA, SAA, SS, PS & PB
X033	Radius cover - E-mags	9000 series E-mags only	Silver, RAL, PAA, SAA, SS, PS & PB
X036	Standard power loop, 350mm long. Supplied as standard with 4000 and 9000 E-mag ranges.	4000 and 9000 series E-mags only	Black
X036	Extended power loop. Various lengths up to 650mm long in 50mm increments.	4000 and 9000 series E-mags only	Black

Floor Springs

CODE	DESCRIPTION	SUITABILITY	FINISH
X050	Cover plates. Supplied as standard with the 2000, 3000 and 900 series.	All floor springs	SS, PS & PB
X051	Single action fitting strap, 16mm.	All floor springs	SS, PS & PB
X052	Single action fitting strap, 25mm. Supplied as standard with the 2000, 3000 and 900 series single action.	All floor springs	SS, PS & PB
X053	Single action top centre, 16mm.	All floor springs	SS, PS & PB
X054	Single action top centre, 25mm. Supplied as standard with the 2000, 3000 and 900 series single action.	All floor springs	SS, PS & PB
X055	Double action fitting strap. Supplied as standard with the 2000, 3000 and 900 series double action.	All floor springs	Zinc plated
X056	Double action top centre. Supplied as standard with the 2000, 3000 and 900 series double action.	All floor springs	SS, PS & PB
X057	Gel infill for improved water resistance.	All floor springs	N/A
X058	Extra height spindles. 5mm to 50mm in 5mm increments.	All floor springs	Black

Single Action:

Top Centre

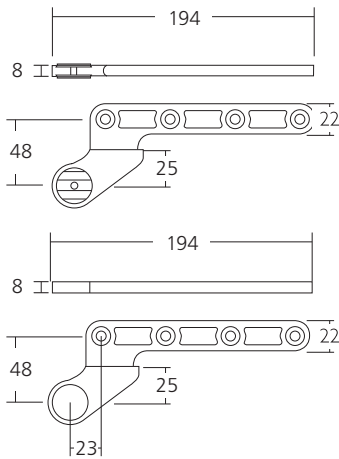

Strap

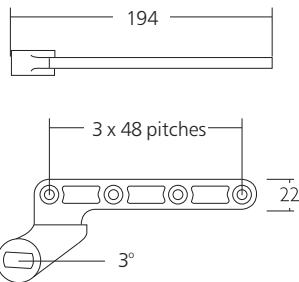

Strap cover



Double Action:

Top Centre

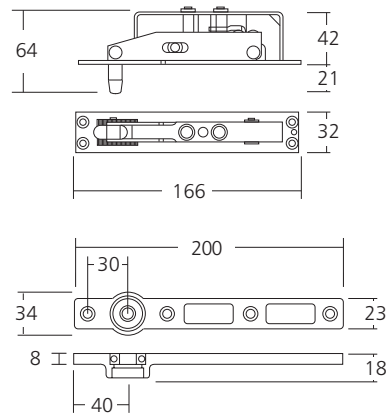

Strap

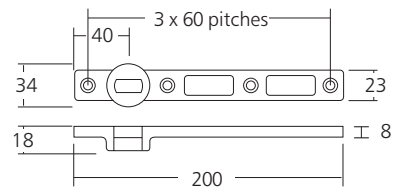

Ultimate Transom Closer

CODE	DESCRIPTION	SUITABILITY	FINISH
RS10-FB	Fixing bracket. Supplied as standard with the Ultimate transom closer series.	Ultimate transom closer	Zinc plated
RS10-SA	Side load arm. Supplied as standard with the Ultimate transom closer series.	Ultimate transom closer	Zinc plated
RS10-EA	End load arm.	Ultimate transom closer	Zinc plated
RS10-HFPSS	Heavy duty floor pivot.	Ultimate transom closer	SS
RS10-CP	Cover plate. Supplied as standard with the Ultimate transom closer series.	Ultimate transom closer	SS, PS & PB
RS10-IP	Intumescent pack.	Ultimate transom closer	N/A
RS10-SP	Extra height spindles. 5mm to 25mm in 5mm increments.	Ultimate transom closer	Black

Concealed and Slimline

CODE	DESCRIPTION	SUITABILITY	FINISH
X060	Slide arm & channel. Supplied as standard with the 6000 range, excl concealed retro fit option.	6000 series	Silver, RAL, SS, PS & PB
X061	Retro slide arm & channel.	6800	Black
X062	Square cover. Supplied as standard with the 6900, 6905, 6930, 6970.	6900, 6905, 6930 & 6970	Silver, RAL, SS, PS & PB

Find It Fast!

You don't need to trawl through catalogues any more. Just use the product specifiers on our new website to take you straight to the specific product you want.



Regulations

The two EN standards for door controls are as follows:-

EN1154 : 1997

The Building Regulations 1991 Approved Document B 2000 Edition requires that all fire-resisting doors (with the exception of locked cupboard/duct doors) be fitted with an appropriate self-closing device.

Within the framework of the Construction Products Directive (89/106/EEC), these devices have been identified as playing an essential role in the safety of buildings in the case of fire. Compliance with BS EN 1154 (and EN1634-1) is deemed to satisfy the requirements of the Directive in this regard, and it is therefore strongly recommended that proof of compliance be obtained for any controlled door closing device before it is specified or used.

Closing controls are available in a range of strengths (commonly referred to as sizes) that relate to the available power to close the door. The minimum performance requirements are laid down in BS EN 1154 - Building hardware - Controlled door closing devices - and include levels of mechanical efficiency, suitable door width and mass.



Classification Coding System for Door Closers

BS EN 1154 classifies door closers using a 6 digit coding system.

Each digit refers to a particular feature of the product measured against the standard's performance requirements.

Example:

Digit: 1 2 3 4 5 6

Classification No.	4	8	2	1	1	3
			5			



Digit 1 - Category of Use

GRADE 3: For closing doors from at least 105° open.
GRADE 4: For closing doors from 180° open.

Digit 2 - Number of test cycles

Only one category is identified:

GRADE 8: 500 000 cycles.

Digit 3 - Test door mass/size

Seven test door grades and related door closer power sizes are identified:

Power size of closer	Width of door (mm)	Maximum mass of door (kg)
1	750	20
2	850	40
3	950	60
4	1100	80
5	1250	100
6	1400	120
7	1600	160

Digit 4 - Fire behaviour

GRADE 0: Not suitable for use on fire/smoke door assemblies.

GRADE 1: Suitable for use on fire/smoke door assemblies, subject to satisfactory assessment of the contribution of the door closer to the fire resistance of specified fire/smoke assemblies. This is assessed outside of BS EN 1154.

Digit 5 - Safety

Only one category is identified:

GRADE 1: All door closer devices are required to satisfy the essential requirement of safety in use.

Digit 6 - Corrosion Resistance

GRADE 0: No defined corrosion resistance.

GRADE 1: Mild resistance.

GRADE 2: Moderate resistance.

GRADE 3: High resistance.

GRADE 4: Very high resistance.

EN1155 : 1997

Electrically powered hold open devices for swing doors

The European standard specifies requirements for hold open devices and also for hold open mechanisms incorporated into a door closer.

Electrically powered hold open devices for swing doors manufactured according to this European standard can hold a swing door at a fixed position or can allow the door to swing freely. In each case, interruption of the electrical supply will cause the controlled door to close positively.



Classification Coding System Electrically Powered Hold Open Devices For Swing Doors

BS EN 1155 classifies electrically powered door closers under a six digit coding system.

Each digit refers to a particular feature of the product measured against the standard's performance requirements.

Example:

Digit: 1 2 3 4 5 6

Classification No.	3	8	4	1	1	3
--------------------	---	---	---	---	---	---



Digit 1 - Category of Use

Only one category is identified:

GRADE 3: For doors for use by the public, and others, with little incentive to take care.

Digit 2 - Number of test cycles

GRADE 5: 50 000 cycles. For all electrically powered hold open devices.
GRADE 8: 500 000 cycles. For all electrically powered hold open devices and free swing door closers and devices that contain operating arms.

Digit 3 - Hold open power size

Five hold open power sizes are identified:

Hold open power size	Recommended door leaf width max (mm)	Test door mass (KG)	Overload test drop weight (kg)	Test door friction Max (N m)
3	950	60	15	0.3
4	1100	80	18	0.4
5	1250	100	21	0.5
6	1400	120	27	0.6
7	1600	160	36	0.8

Digit 4 - Fire behaviour

Only one category is identified:

GRADE 1: Suitable for use on fire/smoke door assemblies, subject to satisfactory assessment of the contribution of the electrically powered hold open device to the resistance of specified fire/smoke door assemblies. This is assessed outside of BS EN1155.

Digit 5 - Safety

All electrically powered hold open devices are required to satisfy the essential requirement of safety in use. Therefore only **GRADE 1** is identified:

Digit 6 - Corrosion Resistance

GRADE 0: No defined corrosion resistance.
GRADE 1: Mild resistance.
GRADE 2: Moderate resistance.
GRADE 3: High resistance.
GRADE 4: Very high resistance.

EXIDOR

National Seal Systems Limited

Unit 210 Holly Road, Western Industrial Estate.
Naas Road, Dublin 12
Ph 00353-1-4565170 Fax 00353-1-4502371
Email: info@nationalseal.ie web: www.nationalseal.ie



Uniclass L4181	EPIC D181
CI/SfB (31.59)	X

Issue 2 EX365

A subsidiary of
chamberlin plc

Every effort has been made to ensure the accuracy of the particulars contained in this brochure. All details and specifications were deemed correct at time of going to press. However, Exidor Limited reserve the right to alter specifications with or without prior notice and at such times in a manner they think fit. Customers are advised to call Exidor Limited on +44 (0) 1543 578661 if they require further details or clarification of specifications.