

Vertical Sliding Sash Hardware Order Form Page 1

Customer Details	
Name	_____
Contact	_____
Phone	_____
email	_____

Finishes Abbreviations	
PB = Polished Brass	AB = Antique Brass
PC = Polished Chrome	SB = Satin Brass
SC = Satin Chrome	BZ = Bronze
CO = Copper	GM = Gun Metal

STOCK FINISHES	PB	PC	SC	CO	FINISHES ON REQUEST	AB	SB	BZ	GM

Style:- SH020
FITCH FASTENER NON LOCKING



Box Qty
10

Quantity	Finish

Style:- SH010
FITCH FASTENER LOCKING

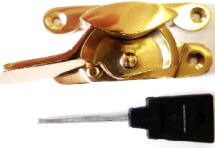

Box Qty
10

Quantity	Finish

Style:- SH090
HOOK FASTENER NONLOCK



Box Qty
10

Quantity	Finish

Style:- SH091
HOOK FASTENER LOCKING



Box Qty
10

Quantity	Finish

Style:- SH060
BRIGHTON FASTENER



Box Qty
10

Quantity	Finish

Style:- SH056
ACORN (BRIGHTON+) FASTENER



Box Qty
10

Quantity	Finish

Style:- SH300
FB32 BRIGHTON FASTENER



Box Qty
10

Quantity	Finish

Style:- THD185L
NARROW LOCKING BRIGHTON FASTENER



Box Qty
10

Quantity	Finish

Style:- SH088
NARROW HOOK FASTENER NONLOCK



Box Qty
10

Quantity	Finish

Style:- SH070
SASH LIFTS



Box Qty
25

Quantity	Finish

Style:- SH075C
SMALL SASH EYE



Box Qty
25

Quantity	Finish

Style:- SH075
SASH EYE TOP FIX



Box Qty
25

Quantity	Finish

Vertical Sliding Sash Hardware Order Form

Customer Details	
Name	_____
Contact	_____
Phone	_____
email	_____

Finishes Abbreviations			
PB =	Polished Brass	AB =	Antique Brass
PC =	Polished Chrome	SB =	Satin Brass
SC =	Satin Chrome	BZ =	Bronze
CO =	Copper	GM =	Gun Metal

STOCK FINISHES	PB	PC	SC	CO	FINISHES ON REQUEST	AB	SB	BZ	GM
----------------	----	----	----	----	---------------------	----	----	----	----

Style:- SH028
AXLE PULLEY ROUND (50KG)



Box Qty	10
Quantity	Finish

Style:- SH030
AXLE PULLEY SQUARE (50KG)



Box Qty	10
Quantity	Finish

Style:- SH041
BB AXLE PULLEY ROUND (60KG)



Box Qty	10
Quantity	Finish

Style:- SH042
BB AXLE PULLEY SQUARE (60KG)



Box Qty	10
Quantity	Finish

Style:- SH045
HD BB PULLEY SQUARE (75KG)



Box Qty	10
Quantity	Finish

Style:- SH044
HD BB PULLEY ROUND BRASS (75KG)



Box Qty	10
Quantity	Finish

Style:- SH105
WEEKES STOP



Box Qty	25
Quantity	Finish

Style:- SH115
ACORN SASH STOP C/W CHAIN BRASS



Box Qty	25
Quantity	Finish

Style:- SH112
BARTHOLEMW SASH LOCK



Box Qty	25
Quantity	Finish

Style:- SH110
SASH VENT LOCK WITH KEY & PLATE



Box Qty	25
Quantity	Finish

Style:- SH078
FLAT SASH EYE BRASS



Box Qty	10
Quantity	Finish

Style:-



Box Qty	1
Quantity	Finish

Vertical Sliding Sash Hardware Order Form Page 3

Customer Name: _____ Contact: _____ Phone: _____	Address: _____ Email: _____ Order No.: _____
---	---

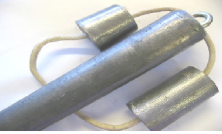
Code:- SH825	
LEAD SASH BAR 45mm ROUND X 1800mm X 30 KGS	
	Box Qty 1
Quantity	

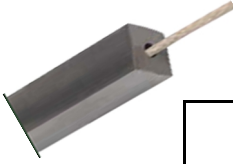
Code:- SH830	
LEAD SASH BAR 45mm Square X 1800mm X 39 KGS	
	Box Qty 1
Quantity	

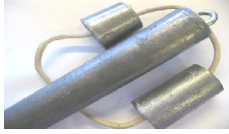
Code:- SH805	
LEAD SASH BAR 1-3/4" ROUND X 600mm X 10KGS	
	Box Qty 1
Quantity	

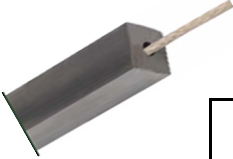
Code:- SH800	
LEAD SASH BAR 1-3/4" Square X 600mm X 13KGS	
	Box Qty 1
Quantity	

Code:- SH600	
NO 4 (6MM)WAXED COTTON SASHCORD POLYESTER CENTRE (100 MTRS)(340KG)	
	Box Qty 1
Quantity	

Code:- SH605	
NO 5 (7MM) WAXED COTTON SASHCORD POLYESTER CENTRE (100 MTRS)(360KG)	
	Box Qty 1
Quantity	

Code:- SH610	
NO 6(8MM)WAXED COTTON SASHCORD POLYESTER CENTRE(100 MTRS)(390KG)	
	Box Qty 1
Quantity	

Code:- SH620	
NO 4 (6MM) 8PLT NYLON WITH CORE (100 MTRS)	
	Box Qty 1
Quantity	

Code:- SH622	
NO 5 (7MM) 8 PLT NYLON WITH CORE (100 MTRS)	
	Box Qty 1
Quantity	

Code:- SH624	
NO 6 (8MM) 8PLT NYLON WITH CORE (100 MTRS)	
	Box Qty 1
Quantity	

Style:- SH195	
POLE HOOK	
	Box Qty 1
Quantity	PB

Code:- SH900	
PULLEYCOVERS (PAIR)	
	Box Qty Pair
Quantity	White