

EXIDOR

200/300 SERIES

PANIC & EMERGENCY EXIT HARDWARE
BOLTS & LATCHES RANGE

 **National
Seal Systems
Limited**

*Unit 210 Holly Road, Western Industrial Estate,
Naas Road, Dublin 12
Ph 00353-1-4565170 Fax 00353-1-4502371
Email: info@nationalseal.ie web: www.nationalseal.ie*



CE  certifire

What's inside

- | | |
|----------------------------------|---------------------|
| 04 Choose your finish | 17 Keep options |
| 05 Product selector | 22 Technical data |
| 08 Single door range | 23 Parts list |
| 12 Rebated double door range | 24 Regulations |
| 13 Non-rebated double door range | 25 Glossary |
| 14 Outside access devices | 26 Product features |
| 16 Accessories | |

Guarantee

To support the high quality and first class engineering that has gone into the Exidor range, the manufacturer gives a ten year guarantee (subject to conditions) against defects due to faulty manufacturing, workmanship or defective material. The manufacturer agrees to replace any defective Exidor product free of charge provided the product has been fitted in accordance with the fitting instructions and maintained correctly.

Technical Support

Comprehensive information and technical support services are available by contacting:

Tel: +44 (0)1543 460040 Fax: +44 (0)1543 570050
email: technical@exidor.co.uk

Or visit our website:

exidor.co.uk

There are a number of enhancements we've made to the Exidor website. You'll also find new company info, technical data, and downloadable pdfs of the latest product literature – all presented in a clear and contemporary style that we hope you'll enjoy.

We're aiming to keep on improving the website, with more new specifiers on the way, and additions to our gallery of products and projects. If you have comments and ideas on ways we can make it even better and more useful, just let us know.





Introducing the 200/300 Series Bolts & Latches

Exidor Ltd is a UK based engineering company manufacturing a comprehensive, high specification range of innovative panic and emergency exit hardware.

We've been meeting the needs of architects, specifiers, project managers, OEM's and building managers for more than 60 years. In that time, we've built an unrivalled record of developing and continually enhancing a product range that's known all over the world.

The Exidor 200 series panic and emergency hardware carries the Certifire quality mark, is fire rated and is CE marked for safety to ensure peace of mind.

The Exidor 200 range combines attractive styling and quality engineering with a choice of fixed or adjustable bolts.

The Exidor 300 range of panic and emergency hardware offers all the benefits of the 200 series, but with the technology and convenience of Pullman latches, offering a smoother and quieter operation, together with greater security. The 300 series is also available as a mortice actuator for use with a cylinder mortice night latch.

The Exidor 300 series offers a choice of either horizontal or vertical Pullman latches.

Both the 200 and 300 series are certified to the European standards:

BS EN 179 – For offices, factories etc

BS EN 1125 – For areas of entertainment, public buildings etc

Certified to 200,000 uses, the 200 and 300 series are available in latch or bolt versions, and accessories include a choice of outside access devices, dogging device, alarm unit, steel door fixing pack and a choice of keeps for different door materials and applications.

What does British manufacturing mean to us?

Understanding what our customers need. Providing local and reliable service. Having a wide range of standard units available from stock for next day delivery. Being able to provide non-standard products. Reacting quickly when it matters. Working to International quality and manufacturing standards and certified to ISO 9001. And caring – professionally – about quality.

Choose Your Finish

Exidor Ltd use epoxy powder coating for all painted surfaces to give a quality finish to our products, and offer silver, black or white as standard colours for the Exidor 200 and 300 series.

Brass and stainless steel plated finishes are also available but are not recommended for external use or outside access devices.

Exidor Ltd also offer a range of popular Hewi & RAL colours to match other ironmongery products that may be fitted. When ordering please suffix the product code with the Hewi or RAL number.

A choice of finishes

All exit devices and outside access devices are available in a wide range of finishes:

Standard finishes:



Silver
(RAL 9022)



Black

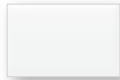

White

Plated finishes available:



Stainless
steel effect



Brass effect

Popular RAL colours available:

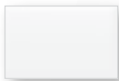

Pure white
9010



Ultra marine
blue
5002



Ruby red
3003



Traffic yellow
1023



Agate grey
7038



Mint green
6029



Ivory
1014



Jet black
9005



Olive
brown
8008



Black green
6012



Wine red
3007



Steel blue
5011



Fir green
6009



Anthracite
grey
7016



Gold



Product Selector

Single doors

EN 179

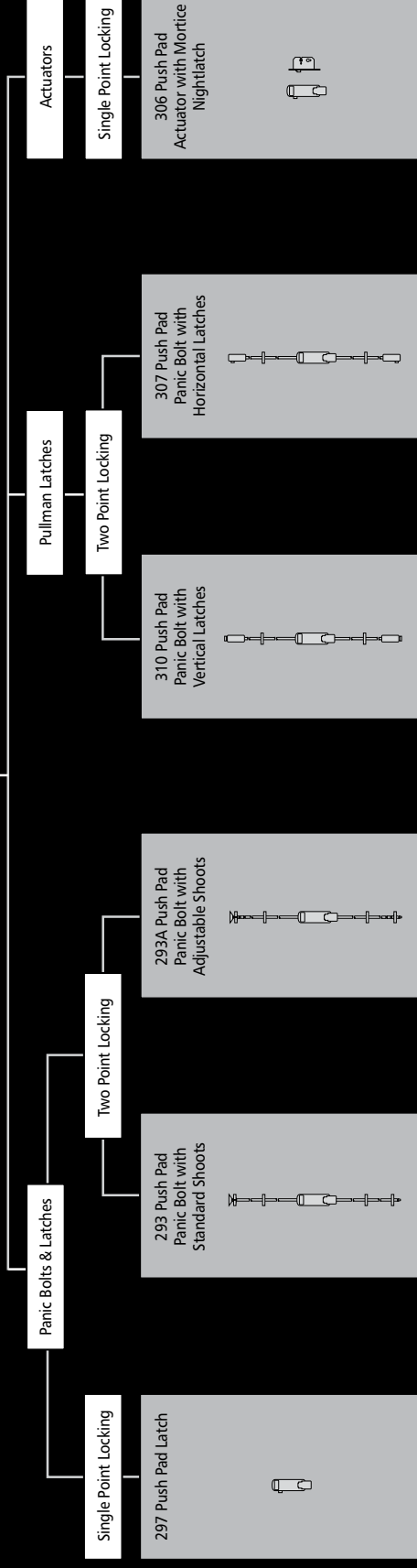

EN 1125

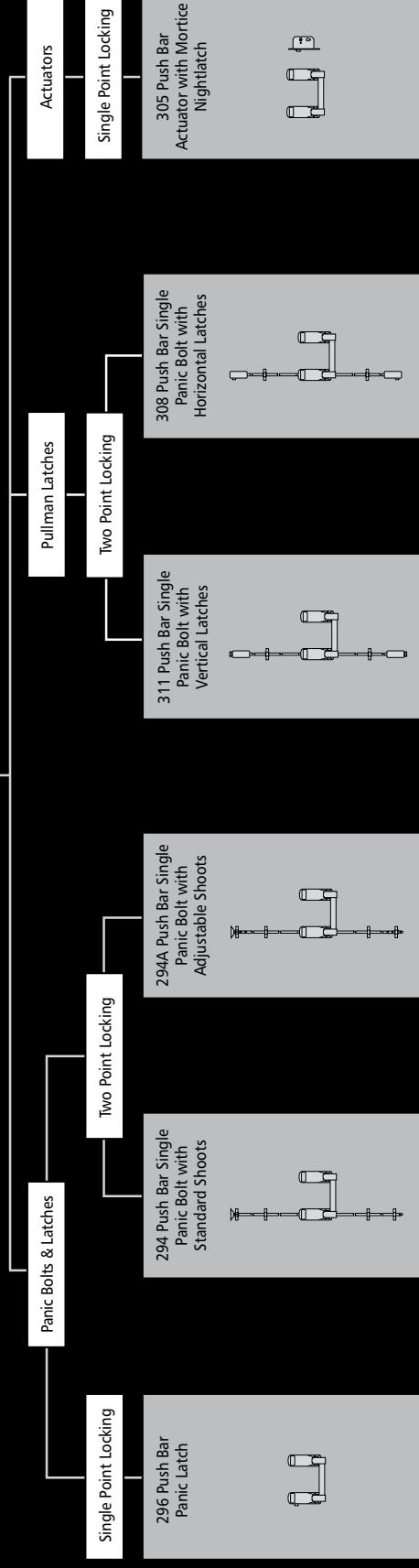

Product Selector

Rebated double doors

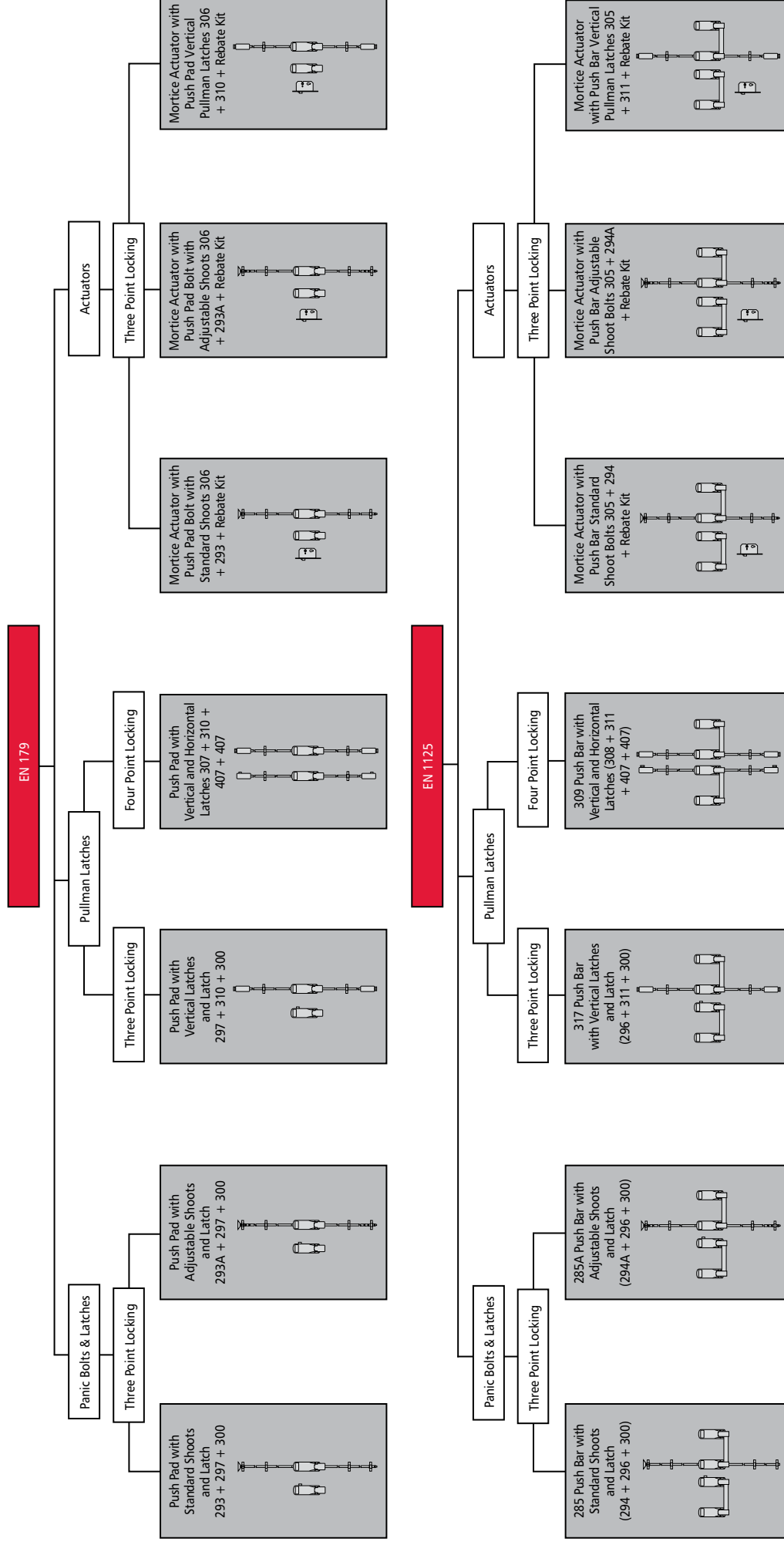

Product Selector

Non-rebated double doors

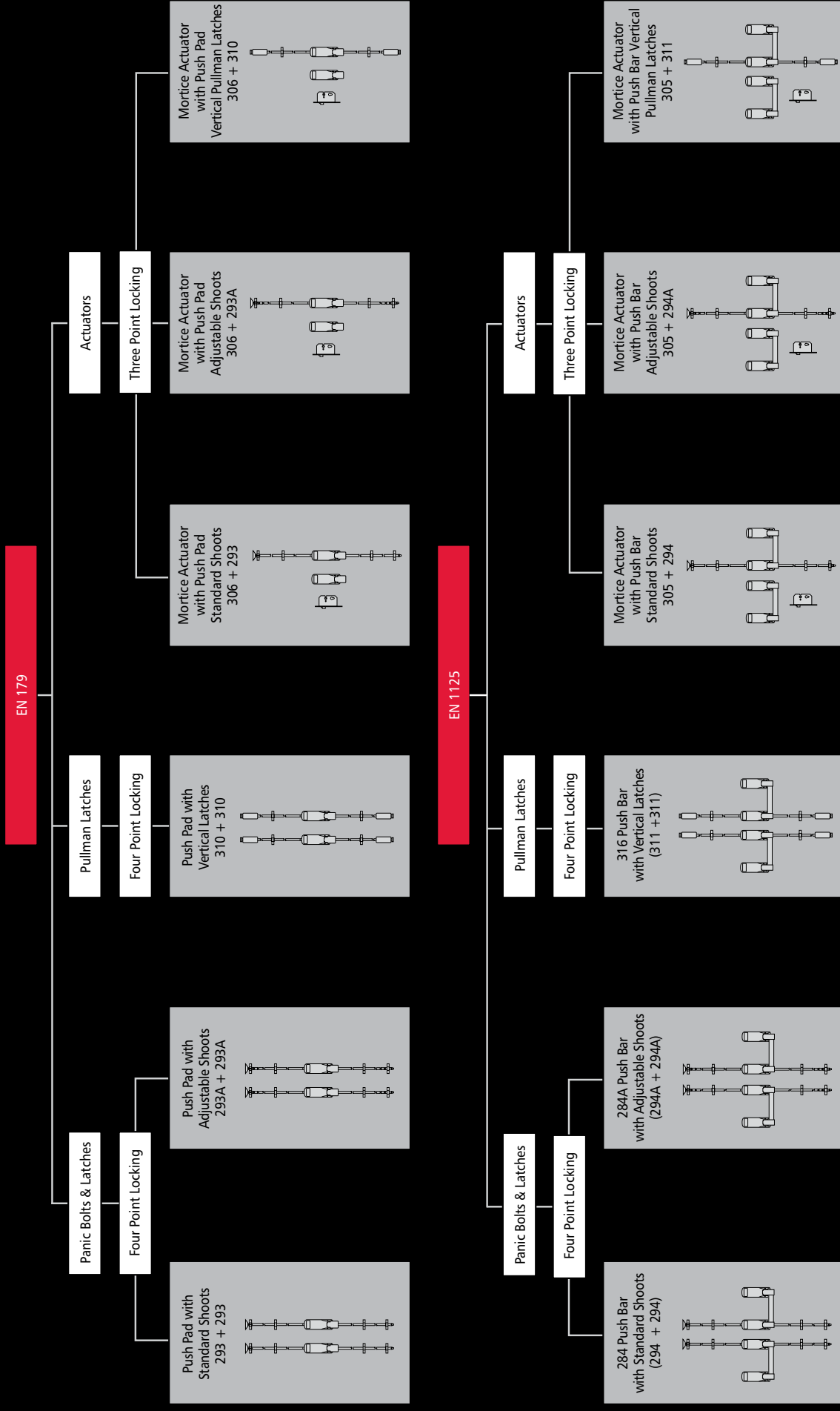

Single Doors 297 | 306

BS EN 179

SINGLE POINT LOCKING



297 Push Pad Panic Latch

Classification No.	3	7	6	B	1	3	4	2	B	A
EN 179 : 2008										

The Exidor 297 is a surface mounted rim latch for single and double door applications. Simply depressing the pad provides safe and speedy exit in the event of an emergency, whilst maintaining security against intrusion. An adapter for use with a rim cylinder for outside access is supplied as standard.

- Non-handed
- Fire rated for use on timber and steel doors
- Surface mounted
- Adapter supplied for operating with a rim cylinder

306 Push Pad Mortice Actuator with Cylinder Mortice Night Latch

Classification No.	3	7	6	0	1	3	4	2	B	A
EN 179 : 2008										

The Exidor 306 offers a push pad actuator unit with a cylinder mortice night latch case that can be supplied with or without a Euro profile cylinder for access from the outside. A mortice plate is supplied as standard. The unit provides security on the outside with ease of escape from the inside in emergency situations.

- Non-handed
- Surface mounted



297

Additional options

The Exidor reversible panic latches can be supplied with:

- Steel door fixings (suffix 'SD' after the product code)

Optional accessories for the 297 panic latch

- 298 Outside access device - knob operated
- 302EA Outside access device with Euro aperture - knob operated
- 302EC Outside access device with Euro cylinder - knob operated
- 302OA Outside access device with oval aperture - knob operated
- 302OC Outside access device with oval cylinder - knob operated
- 322EA Outside access device with Euro aperture - lever operated
- 322EC Outside access device with Euro cylinder - lever operated

Optional accessories for all the panic latches

- CL1 Mechanical push button outside access device
- CL2 Mechanical push button outside access device with passage facility
- CL3 Quick code mechanical push button outside access device
- CL4 Quick code mechanical push button outside access device with passage facility

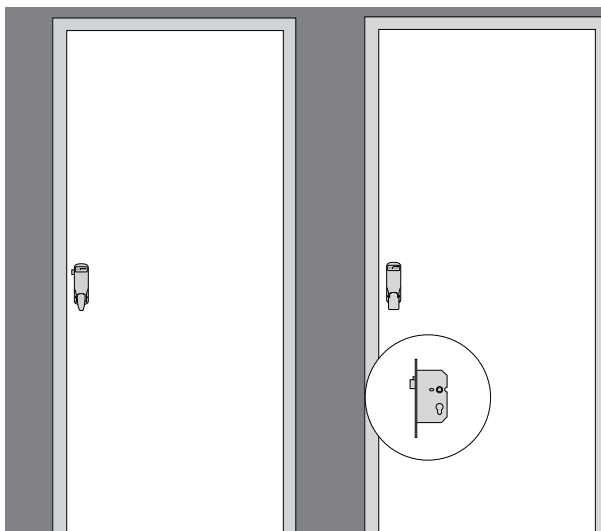

297

306

Single Doors 293 | 307 | 310

BS EN 179

TWO POINT LOCKING



293 Push Pad Single Panic Bolt

Classification No.	3	7	6	B	1	3	4	2	B	A
EN 179 : 2008										

The Exidor 293 is an elegant and highly functional panic bolt for single and double door applications. Incorporated as standard is an automatic top trip and easy clean floor socket. The main body is fitted with an anti-thrust device, which prevents leverage of both the top and bottom shoot bolts from their sockets.

- Non-handed
- Fire rated for use on timber and steel doors
- Surface mounted

307 Push Pad Single Panic Bolt with Horizontal Pullman Latches

Classification No.	3	7	6	B	1	3	4	2	B	A
EN 179 : 2008										

The Exidor 307 offers all the elegance and functions of an Exidor push pad single panic bolt with the added feature of horizontal Pullman latches which increases security and offers a smooth latching action.

- Non-handed
- Surface mounted

310 Push Pad Single Panic Bolt with Vertical Pullman Latches

Classification No.	3	7	6	B	1	3	4	2	B	A
EN 179 : 2008										

The Exidor 310 offers all the elegance and functions of an Exidor push pad single panic bolt with the added feature of vertical Pullman latches which increases security and offers a smooth latching action.

- Non-handed
- Fire rated for use on timber and steel doors
- Surface mounted



Standard sizes

Standard size panic bolts are suitable for single doors up to 2440mm high. Special sizes are available on request.

Additional options

The Exidor reversible panic bolts can be supplied with:

- Adjustable shoots (suffix 'A' after the product code - 293 only)
- Steel door fixings (suffix 'SD' after the product code)

Optional accessories for all the single panic bolts

- 298 Outside access device - knob operated
- 302EA Outside access device with Euro aperture - knob operated
- 302EC Outside access device with Euro cylinder - knob operated
- 302OA Outside access device with oval aperture - knob operated
- 302OC Outside access device with oval cylinder - knob operated
- 322EA Outside access device with Euro aperture - lever operated
- 322EC Outside access device with Euro cylinder - lever operated
- 304 Exit alarm
- 299 Dogging device

Exidor threshold seal ES1 can be fitted as an alternative to the floor keep, Exidor adjustable shoots must be used. Please suffix CB on the product code. i.e 293A/CB (See Exidor Door Seal Range leaflet for details).

Horizontal Pullman Latches



Vertical Pullman Latches

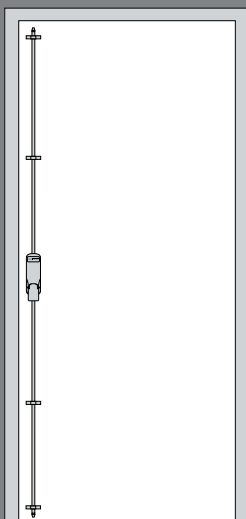

293 / 293A

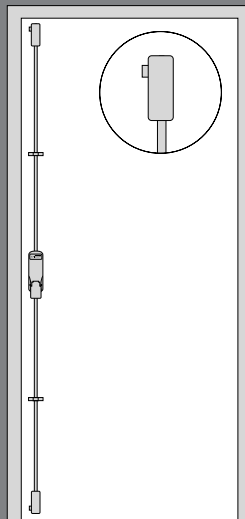

307

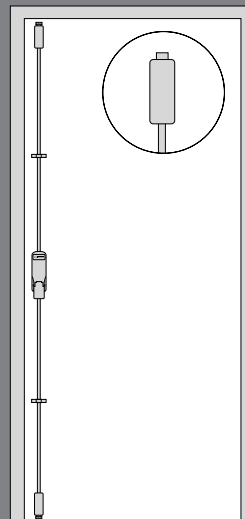

310

Single Doors 296 | 305

BS EN 1125

SINGLE POINT LOCKING



296 Reversible Panic Latch

Classification No.	3	7	6	B	1	3	2	2	A	A
EN 1125 : 2008										

The Exidor 296 is designed for single and double door applications. The unit is operated by a downward thrust of the cross bar to give a speedy exit in panic situations. An adapter for use with a rim cylinder for outside access is supplied as standard.

- Non-handed
- Fire rated for use on timber and steel doors
- Surface mounted
- Adapter supplied for operating with a rim cylinder
- Closed arm design

305 Panic Mortise Actuator with Cylinder Mortise Night Latch

Classification No.	3	7	6	0	1	3	2	2	A	A
EN 1125 : 2008										

The Exidor 305 offers a push bar actuator unit with a cylinder mortise night latch case that can be supplied with or without a Euro profile cylinder for access from the outside. A mortise plate is supplied as standard. The unit provides security on the outside with ease of escape from the inside in panic situations.

- Non-handed
- Surface mounted
- Closed arm design



296

Standard sizes

Standard size panic latches are suitable for single doors up to 1220mm wide. Special sizes are available on request.

Additional options

The Exidor reversible panic latches can be supplied with:

- Steel door fixings (suffix 'SD' after the product code)
- Microswitch (suffix 'MS' after the product code)

Optional accessories for the 296 panic latch

- 298 Outside access device - knob operated
- 302EA Outside access device with Euro aperture - knob operated
- 302EC Outside access device with Euro cylinder - knob operated
- 302OA Outside access device with oval aperture - knob operated
- 302OC Outside access device with oval cylinder - knob operated
- 322EA Outside access device with Euro aperture - lever operated
- 322EC Outside access device with Euro cylinder - lever operated

Optional accessories for all the panic latches

- CL1 Mechanical push button outside access device
- CL2 Mechanical push button outside access device with passage facility
- CL3 Quick code mechanical push button outside access device
- CL4 Quick code mechanical push button outside access device with passage facility

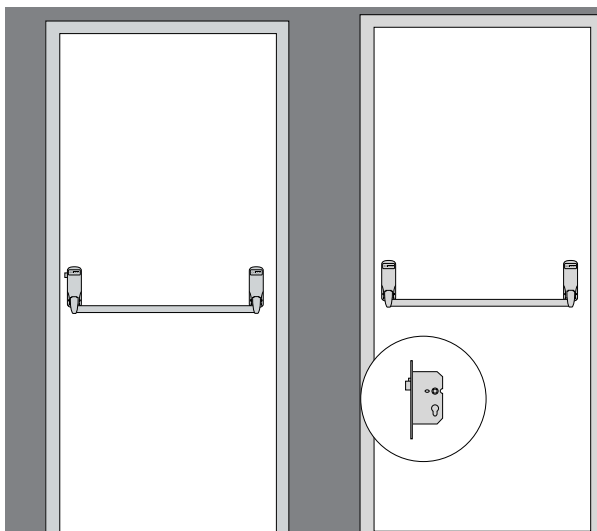

296

305

Single Doors 294 | 308 | 311

BS EN 1125

TWO POINT LOCKING



294 Single Panic Bolt

Classification No.	3	7	6	B	1	3	2	2	A	A
EN 1125 : 2008										

The Exidor 294 is an elegant and highly functional panic bolt for single and double door applications. Incorporated as standard is an automatic top trip and easy clean floor socket. The main body is fitted with an anti-thrust device, which prevents leverage of both the top and bottom shoot bolts from their sockets.

- Non-handed
- Fire rated for use on timber and steel doors
- Surface mounted
- Closed arm design

308 Single Panic Bolt with Horizontal Pullman Latches

Classification No.	3	7	6	B	1	3	2	2	A	A
EN 1125 : 2008										

The Exidor 308 offers all the elegance and functions of an Exidor single panic bolt with the added feature of horizontal Pullman latches which increases the security and offers a smooth latching action.

- Non-handed
- Surface mounted
- Closed arm design

311 Single Panic Bolt with Vertical Pullman Latches

Classification No.	3	7	6	B	1	3	2	2	A	A
EN 1125 : 2008										

The Exidor 311 offers all the elegance and functions of an Exidor single panic bolt with the added feature of vertical Pullman latches which increases the security and offers a smooth latching action.

- Non-handed
- Fire rated for use on timber and steel doors
- Surface mounted
- Closed arm design



Standard sizes

Standard size panic bolts are suitable for single doors up to 1220mm wide and 2440mm high. Special sizes are available on request.

Additional options

The Exidor reversible panic bolts can be supplied with:

- Adjustable shoots (suffix 'A' after the product code - 294 only)
- Steel door fixings (suffix 'SD' after the product code)
- Microswitch (suffix 'MS' after the product code)

Optional accessories for all the panic bolts

- 298 Outside access device - knob operated
- 302EA Outside access device with Euro aperture - knob operated
- 302EC Outside access device with Euro cylinder - knob operated
- 302OA Outside access device with oval aperture - knob operated
- 302OC Outside access device with oval cylinder - knob operated
- 322EA Outside access device with Euro aperture - lever operated
- 322EC Outside access device with Euro cylinder - lever operated
- 304 Exit alarm
- 299 Dogging device

Exidor threshold seal ES1 can be fitted as an alternative to the floor keep, Exidor adjustable shoots must be used. Please suffix CB on the product code. i.e 293A/CB (See Exidor Door Seal Range leaflet for details).

Horizontal Pullman Latches



Vertical Pullman Latches

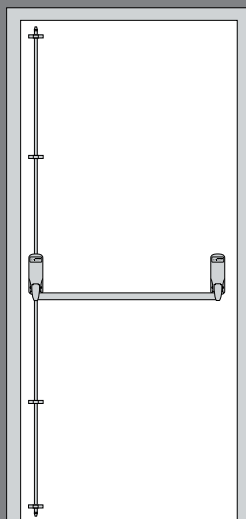

294 / 294A

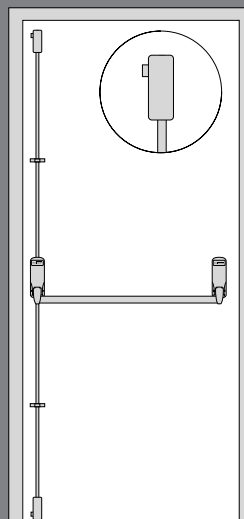

308

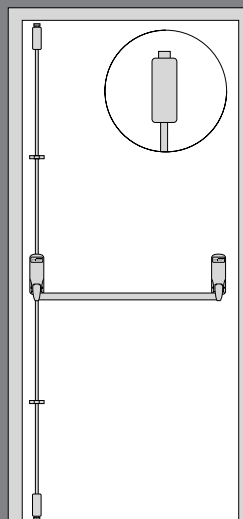

311

Rebated Double Doors 285 | 309 | 317

BS EN 1125

THREE & FOUR POINT LOCKING



285 Double Door Set for Rebated Double Doors

Classification No.	3	7	6	B	1	3	2	2	A	A
EN 1125 : 2008										

The Exidor 285 for rebated double doors is a complete package consisting of a panic latch (296), a panic bolt (294) and a box keep (300).

- Non-handed
- Fire rated for use on timber and steel doors
- Surface mounted
- Closed arm design

309 Double Door Set for Rebated Double Doors

Classification No.	3	7	6	B	1	3	2	2	A	A
EN 1125 : 2008										

The Exidor 309 for rebated double doors is a complete package consisting of a panic bolt with horizontal Pullman latches (308), another panic bolt with vertical Pullman latches (311) and two horizontal Pullman keeps (407).

- Non-handed
- Surface mounted
- Closed arm design

317 Double Door Set for Rebated Double Doors

Classification No.	3	7	6	B	1	3	2	2	A	A
EN 1125 : 2008										

The Exidor 317 for rebated double doors consisting of a panic latch (296), a panic bolt with vertical Pullman latches (311) and a box keep (300).

- Non-handed
- Fire rated for use on timber and steel doors
- Surface mounted
- Closed arm design



Standard sizes

Standard size panic bolts are suitable for single doors up to 1220mm wide and 2440mm high. Special sizes are available on request.

Additional options

The Exidor reversible panic bolts can be supplied with:

- Adjustable shoots (suffix 'A' after the product code - 285 only)
- Steel door fixings (suffix 'SD' after the product code)
- Microswitch (suffix 'MS' after the product code)

Optional accessories for all the rebated double door sets

- 298 Outside access device - knob operated
- 302EA Outside access device with Euro aperture - knob operated
- 302EC Outside access device with Euro cylinder - knob operated
- 302OA Outside access device with oval aperture - knob operated
- 302OC Outside access device with oval cylinder - knob operated
- 322EA Outside access device with Euro aperture - lever operated
- 322EC Outside access device with Euro cylinder - lever operated
- 304 Exit alarm
- 299 Dogging device

Optional accessories for the 285 and 317 rebated double door sets

- CL1 Mechanical push button outside access device
- CL2 Mechanical push button outside access device with passage facility
- CL3 Quick code mechanical push button outside access device
- CL4 Quick code mechanical push button outside access device with passage facility

Exidor threshold seal ES1 can be fitted as an alternative to the floor keep, Exidor adjustable shoots must be used. Please suffix CB on the product code. i.e 293A/CB (See Exidor Door Seal Range leaflet for details).

Horizontal Pullman Latches



Vertical Pullman Latches

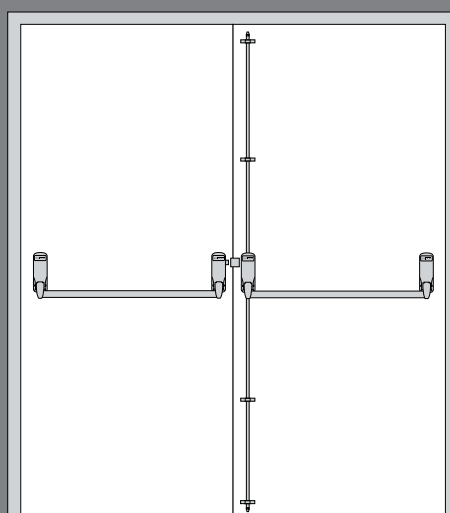

285

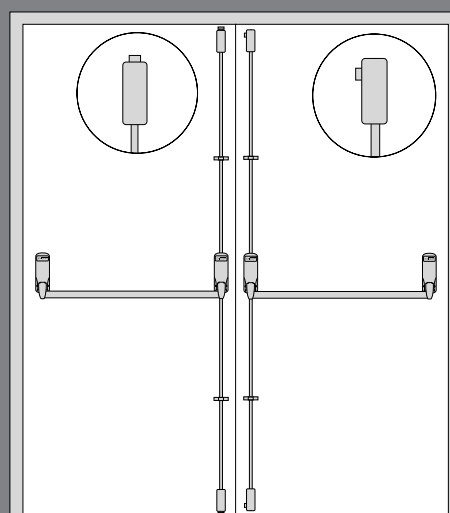

309

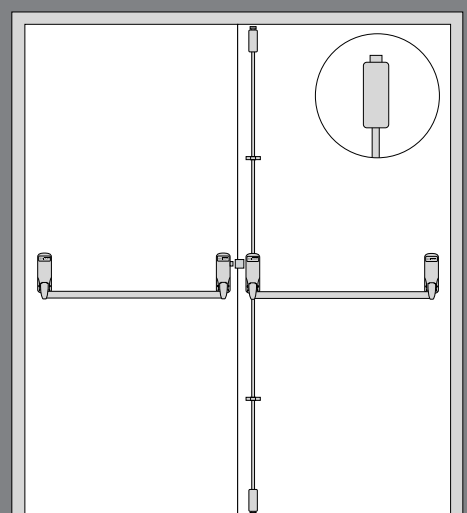

317

Non-Rebated Double Doors 284 | 316 BS EN 1125

FOUR POINT LOCKING



284 Double Door Set for Non-Rebated Double Doors

Classification No.	3	7	6	B	1	3	2	2	A	A
EN 1125 : 2008										

The Exidor 284 for non-rebated double doors is a complete package consisting of two single panic bolts (294).

- Non-handed
- Fire rated for use on timber and steel doors
- Surface mounted
- Closed arm design

316 Double Door Set for Non-Rebated Double Doors

Classification No.	3	7	6	B	1	3	2	2	A	A
EN 1125 : 2008										

The Exidor 316 for non-rebated double doors is a complete package consisting of two panic bolts with vertical Pullman latches (311).

- Non-handed
- Fire rated for use on timber and steel doors
- Surface mounted
- Closed arm design



Standard sizes

Standard size panic bolts are suitable for single doors up to 1220mm wide and 2440mm high. Special sizes are available on request.

Additional options

The Exidor reversible panic bolts can be supplied with:

- Adjustable shoots (suffix 'A' after the product code - 284 only)
- Steel door fixings (suffix 'SD' after the product code)
- Microswitch (suffix 'MS' after the product code)

Optional accessories for all the non-rebated double door sets

- 298 Outside access device - knob operated
- 302EA Outside access device with Euro aperture - knob operated
- 302EC Outside access device with Euro cylinder - knob operated
- 302OA Outside access device with oval aperture - knob operated
- 302OC Outside access device with oval cylinder - knob operated
- 322EA Outside access device with Euro aperture - lever operated
- 322EC Outside access device with Euro cylinder - lever operated
- 304 Exit alarm
- 299 Dogging device

Exidor threshold seal ES1 can be fitted as an alternative to the floor keep, Exidor adjustable shoots must be used. Please suffix CB on the product code. i.e 293A/CB (See Exidor Door Seal Range leaflet for details).

Vertical Pullman Latches

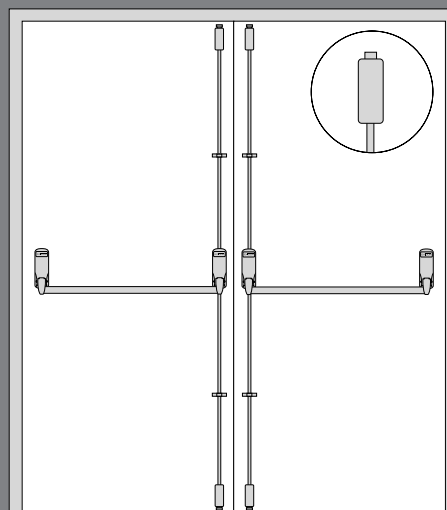
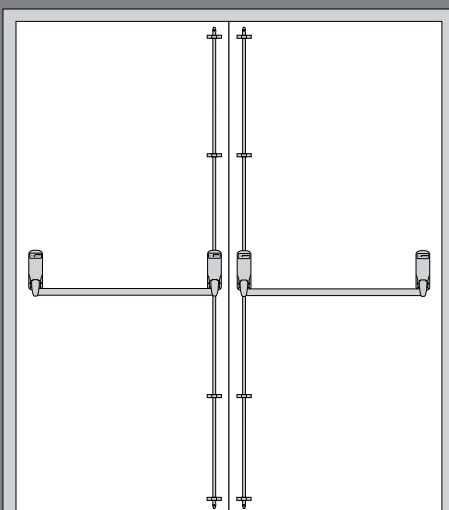

Outside Access Devices



All the Exidor 200/300 series OADs have been certified for use with the Exidor 200/300 range of bolts and latches. The use of any other OAD will invalidate the CE marking on these products.

298 Knob Operated Outside Access Devices

The Exidor 298 is an economical OAD supplied with 2 keys and a 5 pin cylinder which cannot be master keyed. Suitable for use with the Exidor 200 & 300 series bolts and latches, the Exidor 298 offers access from the outside of the door.

- Non-handed
- Fire rated for use on timber and steel doors
- Surface mounted on the outside of the door using concealed machine screws
- Supplied as standard for doors up to 60mm thick.
- Longer spindles and screws are available on request for door thicknesses over 60mm.

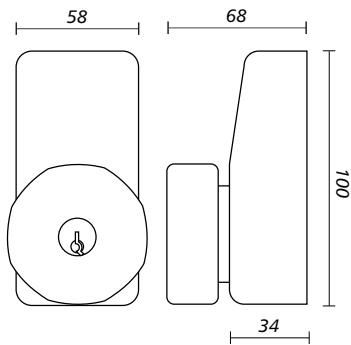

All measurements in mm



298

302 Knob Operated Outside Access Devices

The Exidor 302 is supplied with 3 keys and has the advantage that a master keyed 40mm oval or Euro profile cylinder can be used. Suitable for use with the Exidor 200 & 300 series bolts and latches, the Exidor 302 offers access from the outside of the door.

- Non-handed
- Fire rated for use on timber and steel doors
- Surface mounted on the outside of the door using concealed machine screws
- Supplied as standard for doors up to 45mm thick.
- Longer spindles and screws are available on request for door thicknesses over 45mm.

Performance

When locked, the mechanism is disengaged allowing the knob to freely rotate. When unlocked, the knob, spindle and mechanism engage allowing the shoots or latches of the panic bolt, or the panic latch, to be withdrawn from the outside. The knob remains engaged until it is re-locked.

Finishes

A choice of finishes are available (see page 4). However, plated finishes are not recommended for external environments as harsh conditions can break down the plating.

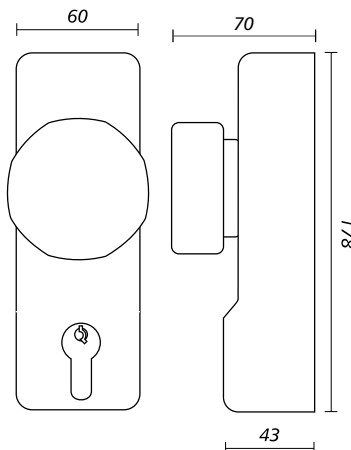

All measurements in mm



302EC

Options available

- 302EA outside access device with Euro profile aperture
- 302EC outside access device supplied with Euro cylinder
- 302OA outside access device with oval profile aperture
- 302OC outside access device supplied with oval cylinder
- 302KA outside access device with Kaba profile aperture
- 302EC/RK outside access device with key retention supplied with Euro cylinder
- 302EA/RK outside access device with key retention with Euro profile aperture

322 Lever Operated Outside Access Device

The Exidor 322 offers a lever operated outside access device that meets the dimensional requirements of BS8300 and approved Document "M" (DDA).

The 322 is supplied with 3 keys and has the advantage that a master keyed 45mm Euro profile cylinder can be used. Suitable for use with the Exidor 200 & 300 series, the 322 offers access from the outside of the door.

- Non-handed
- Meets the dimensional requirements of BS8300 and approved Document "M" (DDA)
- Lever is supplied with special shear screw designed to break under excessive force
- Surface mounted on the outside of the door using three concealed machine screws
- Same fixing points as the 302 OAD - easy retro fit
- Supplied as standard for doors up to 55mm thick
- Longer spindles available on request for door thicknesses over 55mm
- Longer spindles available on request for door thicknesses over 70mm

Performance

When locked, the lever is fixed in the horizontal position and the shear screw is designed to break under excessive force to prevent unauthorised entry. When unlocked, the lever, spindle and mechanism engage allowing the shoots, latch or Pullman latches to be withdrawn from the outside. The lever remains engaged until the mechanism is re-locked.

Finishes

A choice of finishes are available (see page 4). However, plated finishes are not recommended for external environments as harsh conditions can break down the plating.

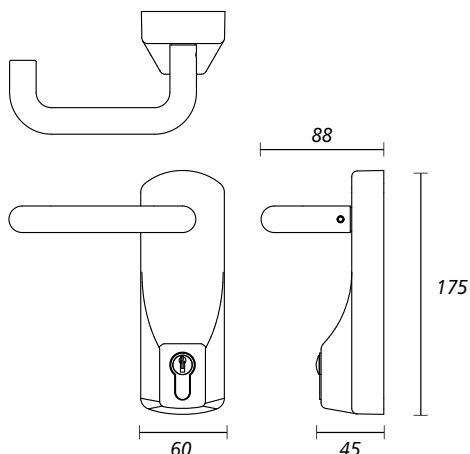

All measurements in mm

Mechanical Push Button Outside Access Devices

Only suitable for use with the 296, 297, 305 and 306.

CL1 Push Button Mechanical Code Lock

CL2 Push Button Mechanical Code Lock with Passage Function

CL3 Quick Code Mechanical Code Lock

(Code can be changed without removing the unit)

CL4 Quick Code Mechanical Code Lock with Passage Function

(Code can be changed without removing the unit)

- 1,584 different codes available
- Non handed
- Reversible safety lever
- Surface mounted using concealed screws
- Clutch protection on the outside lever
- Supplied with spindles for doors from 35mm to 60mm thick
- PVD weather resistant finish
- Available in stainless steel or brass finishes



322EC

Options available

- 322EA Lever operated OAD with Euro profile aperture
- 322EC Lever operated OAD supplied with Euro cylinder



CL1 / CL2



CL3 / CL4

Accessories



299 Dogging Device

For use with the Exidor panic bolt and Pullman latch ranges, a dogging device is available as an accessory (Exidor 299). The dogging device allows the bolts to be withheld in the retracted position ensuring the automatic top trip catch or Pullman latch do not engage when the door is closed.



299

304 Alarm Unit

For use with the Exidor panic bolt and Pullman latch ranges, the alarm is activated when the panic device is operated or an attempt is made to remove the cover, and de-activated by a key. The unit is powered by a 9v battery.



304

314 Vertical Pullman Latch Kit

315 Horizontal Pullman Latch Kit

The Exidor Pullman latch kits can be supplied for any of the Exidor panic bolt range to upgrade a unit, and are suitable for doors that are subject to a high volume of traffic, or when a higher level of security is required.

The Pullman latches are available in both vertical and horizontal versions and provide a smooth and quiet alternative to the traditional top trip catch. They are recommended for interconnecting doors as well as external doors. The level of security is increased as the latches operate independently and yet they maintain the emergency facility in that they are retracted in one action by the cross bar, push pad or touch bar when required. The Pullman latches are housed in an enclosed keep and are designed so that they can only be attacked by going through the door. However, due to the design, the latch will throw outwards rather than retract if attacked, thus increasing security.



314

315

Accessories For Non-Standard Doors

For doors that exceed the size of 1220mm wide and 2440mm high, the following top shoots and oval push bar tubes are available.

Top Shoot Tube

P0801 1210mm top shoot tube for doors up to 2440mm high

P0802 1600mm top shoot tube for doors up to 2680mm high

P0803 2100mm top shoot tube for doors up to 3180mm high

Oval Push Bar Tube

P1001 1180mm oval push bar tube for panic bolts up to 1220mm wide

P1002 1600mm oval push bar tube for panic bolts up to 1650mm wide

P1003 2100mm oval push bar tube for panic bolts up to 2150mm wide

Mortice Actuator Accessories

P3054 Euro profile cylinder for cylinder mortice night latch

P1803 Key blank for Euro profile cylinder

RK13 13mm rebate set for cylinder mortice night latch

RK25 25mm rebate set for cylinder mortice night latch

* Please note that rebate kits are handed.

Left hand rebate kit

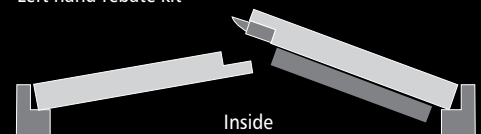

Inside

Right hand rebate kit

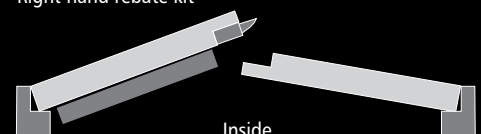

Inside

Keep Options

TIMBER DOOR KEEPS

Latch Bolt Keeps

P1601 Standard Latch Keep

- 200 series latch keep
- Supplied as standard with the 296 and 297 panic latches

Construction - mild steel
 Finish - electro galvanised
 plated finish not available

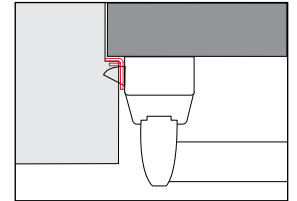
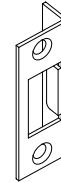

P1601

ED150 Latch Keep

- 200 series latch keep for timber and steel frames.
- Surface mounted.
- No clearance hole to accept latch is required

Construction - diecast zinc
 Finish - powder coated / RAL finish available on request
 plated finish not available

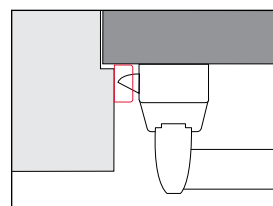
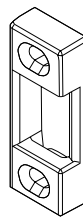

ED150 - Single Door

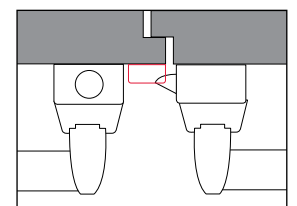

ED150 - Double Door

300 Double Rebated Door Keep

- Used for rebated double doors for the Exidor 296 Push bar panic latch and 297 push pad panic latch.

Construction - mild steel
 Finish - powder coated / RAL finish available on request
 plated finish available

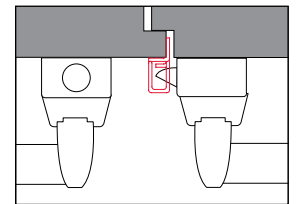
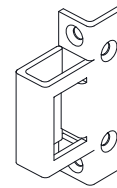

300

Top Bolt Keeps

P0401 Top Trip

- Used for standard bolts on timber frames.
- Supplied as standard with the 294 and 293 panic bolts

Construction - mild steel
 Finish - electro galvanised / RAL finish available on request
 plated finish not available

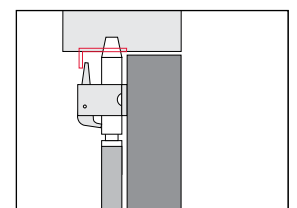
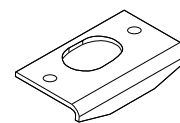

P0401

2405 Top Trip

- Surface mounted keep for top shoot bolts on timber and steel frames
- For flush fitting doors / frames
- Used with 200 series panic bolts

Construction - mild steel
 Finish - electro galvanised / RAL finish available on request
 plated finish not available

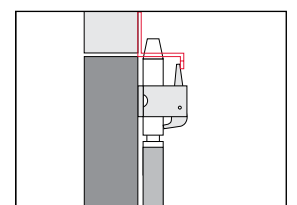
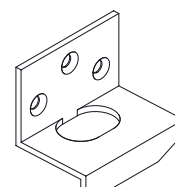

2405

3405A Top Trip

- Surface mounted keep for timber top header rail
- No clearance hole in the header rail to accept the top shoot bolt is required

Construction - diecast zinc / mild steel
Finish - electro galvanised
plated finish not available

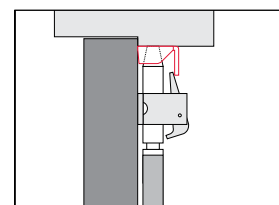
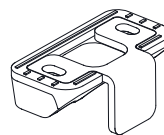

3405A

2401 Top Trip

- Surface mounted keep for top shoot bolts
- Kit supplied includes spacers for applications where the distance between the header rail and the door face is between 14mm and 21mm

Construction - mild steel
Finish - electro galvanised / RAL finish available on request
plated finish not available

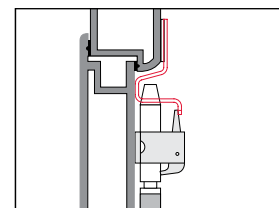
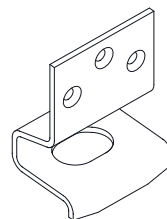

2401

Bottom Bolt Keeps

2403 Low Threshold Bottom Keep

- For low thresholds or an alternative to boring a hole in a concrete floor to accept the bottom shoot bolt
- Designed to the requirements of CEN standards and building regulations

Construction - mild steel
Finish - electro galvanised / RAL finish available on request
plated finish not available

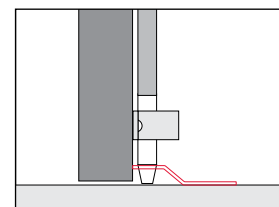
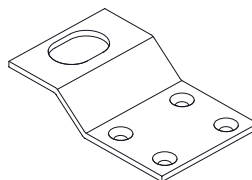

2403

3405 Bottom Keep

- Surface mounted keep for bottom shoot bolts
- No clearance hole in the floor is required

Construction - diecast zinc
Finish - electro galvanised
plated finish not available

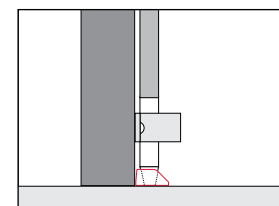
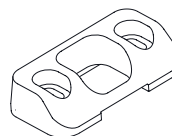

3405

Pullman Latch Keeps

3401 Vertical Pullman Latch Keep

- For 300 series vertical Pullman latches on flush fitting doors / frames

Construction - mild steel
Finish - electro galvanised / RAL finish available on request
plated finish not available

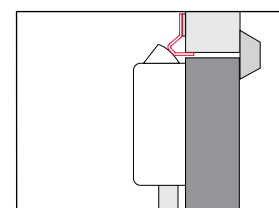
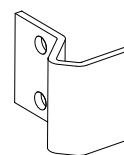

3401

3402 Vertical Pullman Latch Keep

- For 300 series vertical Pullman latches
- Supplied as standard with all Pullman latch units

Construction - diecast aluminium
Finish - powder coated black
plated finish not available

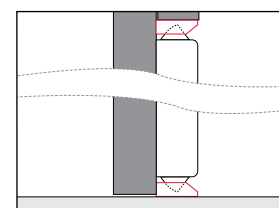
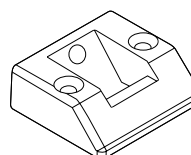

3402

407 Horizontal Pullman Latch Keep

- Used with Exidor horizontal Pullman latches for both flush fitting doors/frames and on double rebated door applications
- Supplied as standard with the 307 and 308 panic bolt

Construction - mild steel
Finish - electro galvanised / RAL finish available on request
plated finish available

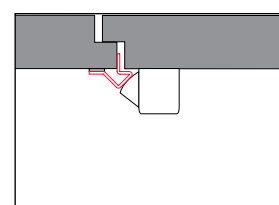
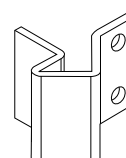

407

STEEL DOOR KEEPS

Latch Bolt Keeps

ED150 Latch Keep

- 200 series latch keep for timber and steel frames
- Surface mounted
- No clearance hole to accept latch is required

Construction - diecast zinc

Finish - electro galvanised / RAL finish available on request
plated finish not available

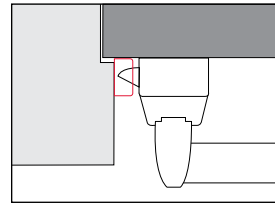
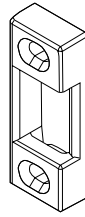

ED150 - Single Door

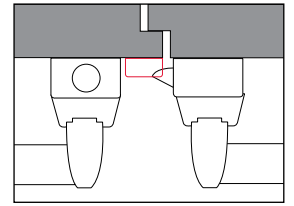

ED150 - Double Door

3404 Latch Keep

- 200 series latch keep for steel frames

Construction - mild steel

Finish - electro galvanised
plated finish not available

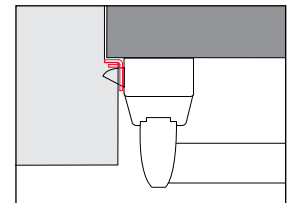
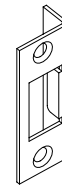

3404

300 Double Rebated Door Keep

- Used for rebated double doors for the Exidor 296 push bar panic latch and 297 push pad panic latch

Construction - mild steel

Finish - electro galvanised / RAL finish available on request
plated finish available

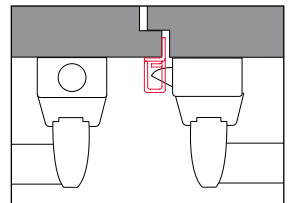
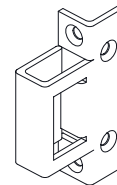

300

Top Bolt Keeps

2405 Top Trip

- Surface mounted keep for top shoot bolt on timber and steel frames
- For flush fitting doors / frames
- Used with 200 series panic bolts

Construction - mild steel

Finish - electro galvanised / RAL finish available on request
plated finish not available

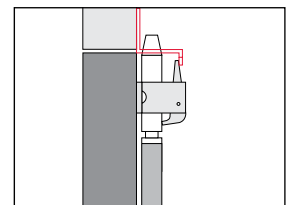
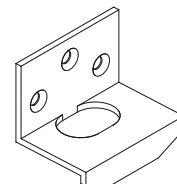

2405

3405A/SD Keep

- Surface mounted keeps for steel top header rail
- No clearance hole in the header rail to accept the top shoot bolt is required

Construction - diecast zinc / mild steel

Finish - electro galvanised
plated finish not available

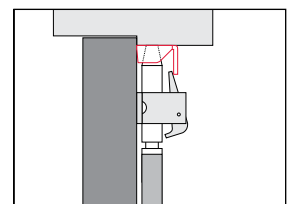
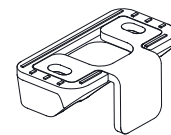

3405A/SD

Bottom Bolt Keeps

2403 Low Threshold Bottom Keep

- For low thresholds or an alternative to boring a hole in a concrete floor to accept the bottom shoot bolt
- Design to the requirements of CEN standards and building regulations

Construction - mild steel

Finish - electro galvanised / RAL finish available on request
plated finish not available

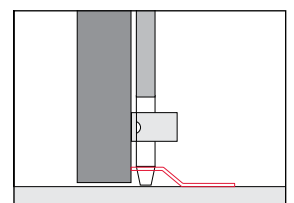
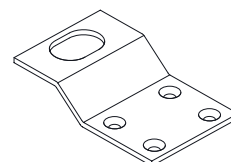

2403

3405 Bottom Keep

- Surface mounted keep for bottom shoot bolts
- No clearance hole in the floor is required

Construction - diecast zinc

Finish - electro galvanised
plated finish not available

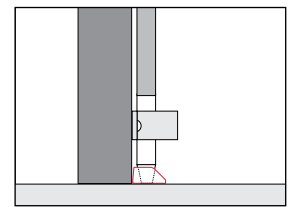
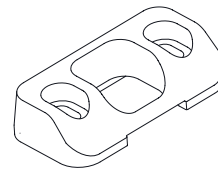

3405

Pullman Latch Keeps

3401 Vertical Pullman Latch Keep

- For 300 series vertical Pullman latches on flush fitting doors / frames

Construction - mild steel

Finish - electro galvanised / RAL finish available on request
plated finish not available

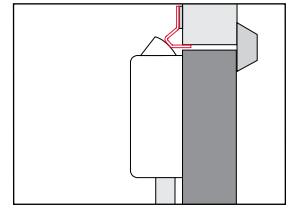
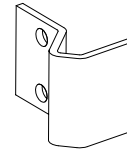

3401

3402 Vertical Pullman Latch Keep

- For 300 series vertical Pullman latches
- Supplied as standard with all Pullman latch units

Construction - diecast aluminium

Finish - powder coated black
plated finish not available

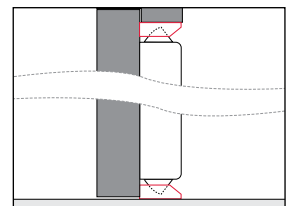
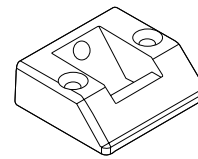

3402

407 Horizontal Pullman Latch Keep

- Used with Exidor horizontal Pullman latches for both flush fitting doors/frames and on double rebated door applications
- Supplied as standard with the 307 and 308 panic bolts

Construction - mild steel

Finish - electro galvanised / RAL finish available on request
plated finish available

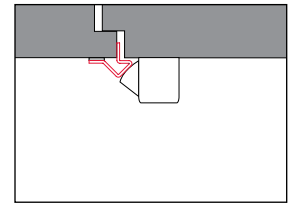
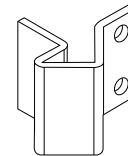

407

UPVC DOOR KEEPS

Top Bolt Keeps

2401 Top Trip

- Surface mounted keep for top shoot bolts
- Kit supplied includes spacers for applications where the distance between the header rail and the door face is between 14mm and 21mm

Construction - mild steel

Finish - electro galvanised / RAL finish available on request
plated finish not available

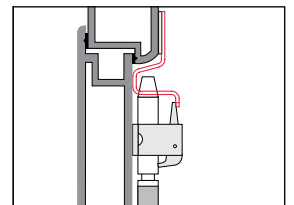
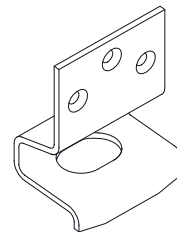

2401

Bottom Bolt Keeps

2403 Low Threshold Bottom Keep

- For low thresholds or an alternative to boring a hole in a concrete floor to accept the bottom shoot bolt
- Design to the requirements of CEN standards and building regulations

Construction - mild steel

Finish - electro galvanised / RAL finish available on request
plated finish not available

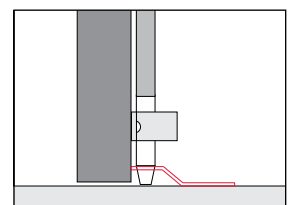
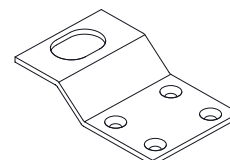

2403

3405 Bottom Keep

- Surface mounted keep for bottom shoot bolts
- No clearance hole in the floor is required

Construction - diecast zinc
Finish - electro galvanised
plated finish not available

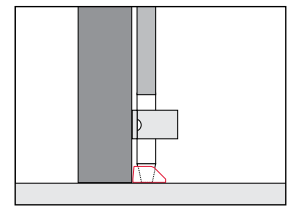
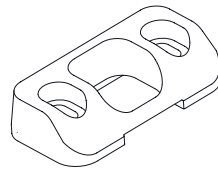

3405

2402 Bottom Keep

- For UPVC doors / frames that have a high threshold
- Complete with spacers for applications where the distance between the door face and face of the threshold is between 14mm and 21mm
- Ideal to use with 2401 top trip keep

Construction - mild steel
Finish - electro galvanised / RAL finish available on request
plated finish not available

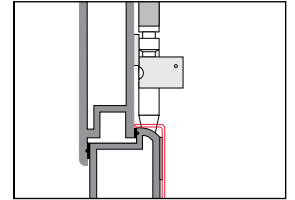
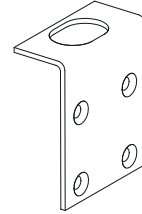

2402

Pullman Latch Keeps

3401 Vertical Pullman Latch Keep

- For 300 series vertical Pullman latches on flush fitting doors / frames

Construction - mild steel
Finish - electro galvanised / RAL finish available on request
plated finish not available

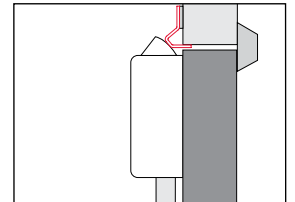
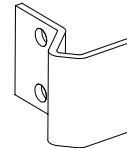

3401

3402 Vertical Pullman Latch Keep

- For 300 series vertical Pullman latches
- Supplied as standard with all Pullman latch units

Construction - diecast aluminium
Finish - powder coated black
plated finish not available

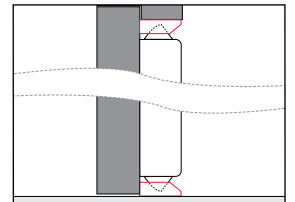
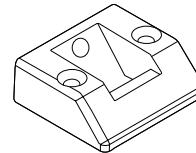

3402

407 Horizontal Pullman Latch Keep

- Used with Exidor horizontal Pullman latches for both flush fitting doors/frames and on double rebated door applications
- Supplied as standard with the 307 and 308 panic bolts

Construction - mild steel
Finish - powder coated silver / RAL finish available on request
plated finish available

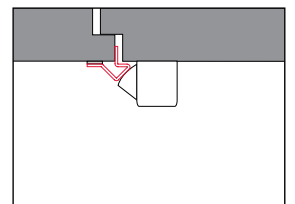
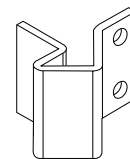

407

3403 Keep

- Used for 300 series horizontal latches on UPVC double doors
- Optional longer version available (SL-0156)

Construction - mild steel
Finish - electro galvanised / RAL finish available on request
plated finish not available

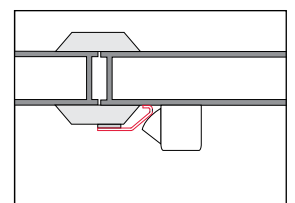
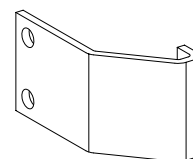

3403

Technical Data

Maintenance

It is important that all panic and emergency exit hardware devices are inspected and maintained properly to ensure safety is maintained when exiting a building in any situation.

Once the device is fitted regular maintenance is recommended.

Weekly:

- Make sure the exit device functions correctly
- Any fixings that have worked loose should be re-secured
- Any damaged components should be replaced
- Ensure there are no obstructions which prevent the panic unit from functioning correctly

Every three months:

- Check for wear. Any visible worn components should be replaced

Fixing / Installation

Installation instructions are supplied with all the Exidor panic and emergency exit hardware. Provided the instructions are followed and the units are fitted by a competent person, the Exidor range will offer a high degree of safety and security. No responsibility can be accepted by the manufacturer if the installation instructions are not followed.

In order to meet the CEN European standards the door and frame should be of good quality and suitable to support the hardware.

Make sure that any weather strips or fixings on the door or frame do not interfere with the opening and closing of the door.

All bars and shoots should be cut to the exact size on site and each is supplied with loose end plugs. Unless specified all the Exidor range is supplied with all the necessary fixings for timber frames and doors. However, for alternative fixings for steel doors please contact the manufacturer or your supplier.

Construction

The main body and slave units are constructed of die cast aluminium with extruded aluminium guides. The internal components and shoot ends are of solid steel with tubular steel shoots, and the latch bolts are in extruded brass.

Passivate Protection - On Request

The passivation process gives extra protection to the steel components and is recommended when the product is to be used in harsh conditions, such as outside gates, around swimming pools or coastal areas.

Chromating - On Request

Chromating offers increased protection to the aluminium components in harsh condition such as outside gates, around swimming pools or coastal areas.

Standard Sizes

Standard sized units are suitable for doors up to 1220mm wide and 2440mm high. The shoot bolts and cross bars can be cut down on site to suit the door height and width.

For larger doors above 2440mm height special size top shoot bolt lengths are available up on request. The following lengths are stocked by Exidor Ltd.

- 1210mm for doors up to 2440mm high (Standard size supplied)
- 1600mm for doors up to 2680mm high
- 2100mm for doors up to 3180mm high

Threshold Seal

The ES1 threshold seal plate is for outward opening broad butt hinged doors. The seal meets the requirements of the Disability Discrimination Act and has been fire, smoke and acoustic tested.

Fire Rating

The Exidor 200 and 300 series is approved by Certifire for use on timber and steel doors to EN1634-1 : 2000. The rating will depend on the certification of the fire door. It is important to realise that the hardware is required for the first part of the test until the door is sealed into the frame. After this period of time the fire door is then responsible for sealing off the area.

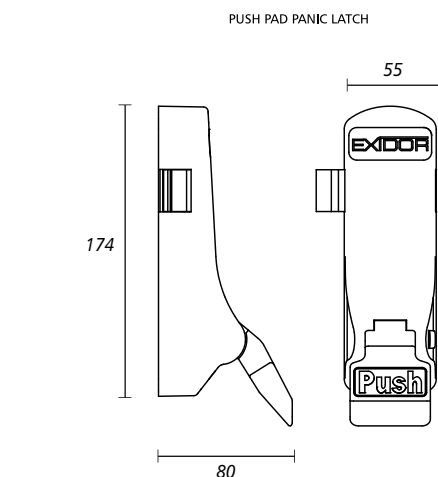

All measurements in mm

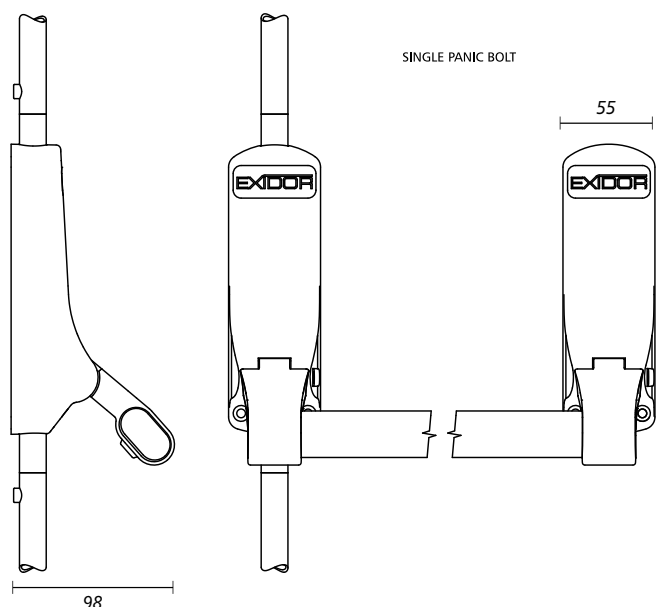

Parts List

1. Panic Push Bar
2. Top Shoot Tube
3. Bottom Shoot Tube
4. Guide
5. Top Trip Assembly
6. Bottom Guide
7. Bottom Keep Plate
8. Panic Bolt Body Assembly
9. Slave Unit
10. Push Pad Panic Latch Assembly
11. Push Bar End Plugs
12. Top Shoot Bolt
13. Bottom Shoot Bolt
14. Push Pad Label
15. Foil Label
16. Vertical Pullman Latch
17. Horizontal Pullman Latch
18. Latch Keep
19. Top Trip Plate
20. Tube Screws
21. Pullman Latch Keep

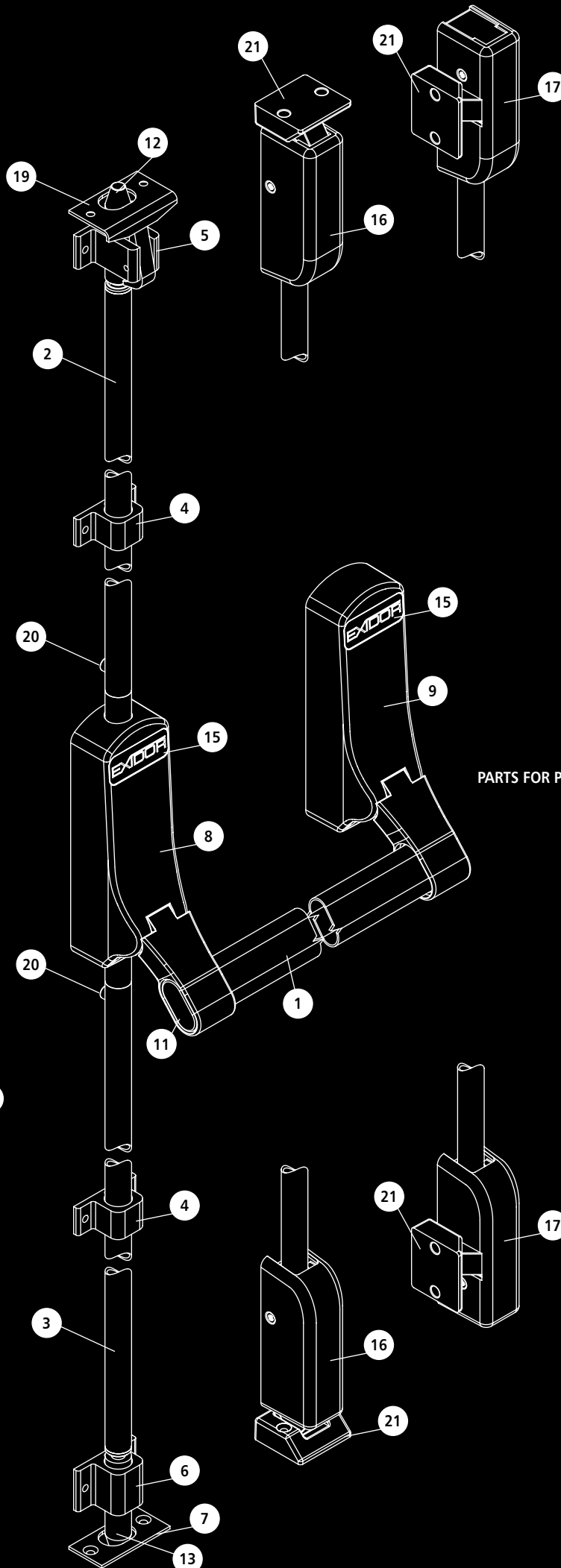

PARTS FOR PUSH BAR PANIC BOLT

PARTS FOR PUSH PAD PANIC LATCH

Regulations

The two standards for panic and emergency exit hardware are as follows:-

EN179: 2008

For push pad and lever handle devices which can only be used in areas where occupants of the building are familiar with the layout and means of escape, and where members of the public do not have access.

Application examples: factory, warehouse, offices



EN1125: 2008

For push bar and touch bar devices which can be used in any environment, particularly areas open to members of the public.

Application examples: shopping centres, areas of entertainment, public buildings



Classification Coding System for Panic and Emergency Exit Hardware

Under both these two standards each product is tested and classified accordingly to show its compliance by the identification of a 10-digit code that is visible on the product and fitting instructions. Each digit represents a category and how it measured against the standard to which it was tested.

Example:

Digit: 1 2 3 4 5 6 7 8 9 10

Classification No.	3	7	6	B	1	3	2	2	A	A
--------------------	---	---	---	---	---	---	---	---	---	---



Digit 1 - Category of Use

Only one category is identified

3 = high frequency of use where there is little incentive to exercise care, i.e. where there is a chance of an accident occurring and misuse.

Example: Doors to shops, hospitals, schools and other buildings which provide access to designated areas and which are used by the public and others frequently carrying or propelling bulky objects.

Digit 2 - Durability

6 = tested up to 100,000 cycles

7 = tested up to 200,000 cycles

Digit 3 - Door Mass

5 = for doors up to 100kg

6 = for doors up to 200kg

7 = for doors over 200kg

Digit 4 - Suitability for use on fire / smoke doors

0 = not approved for use on fire / smoke door assemblies

A = suitable for use on smoke door assemblies

B = Suitable for use on fire and smoke door assemblies based on a test in accordance with EN1634-1

Digit 5 - Safety

Only the top grade is allowed on panic and emergency exit hardware

1 = safety

Digit 6 - Corrosion Resistance to EN 1670

3 = high resistance

4 = very high resistance

Digit 7 - Security for Products

EN 1125

2 = 1,000 N - this is the grade allowed under EN 1125

EN 179

2 = 1,000N / 3 = 2,000N / 4 = 3,000N / 5 = 5,000N

These four grades are used to allow the opportunity of greater security because these devices are subject to testing with doors under a greater pressure.

Digit 8 - Projection of Device

1 = large projection (projection of 150mm from the face of the door)

2 = standard projection (projection of 100mm from the face of the door)

Digit 9 - Type of Device

EN 179

A = emergency device using a lever handle

B = emergency device using a push pad

EN 1125

A = panic device using a push bar

B = panic device using a touch bar

Digit 10 - Door Application

EN 179

A = outwardly opening single exit door, double exit door: active or inactive leaf

B = outwardly opening single exit door only

C = outwardly opening double exit door: inactive leaf only

D = inwardly opening single exit door only

EN 1125

A = single door, double door: active or inactive

B = single door only

C = double door, inactive leaf only

Glossary

Emergency Exit Hardware

Products that are classified as emergency exit hardware offer a single operation of a lever or push pad to release the device. These are certified to EN 179 and can be used on premises that require prior knowledge of its operation and where panic situations are not foreseen, such as offices and areas that are not open to the public.

Panic Exit Hardware

Products that are classified as panic exit hardware offer a single operation of a push bar or touch bar to release the device. These are certified to EN 1125 and can be used on premises that do not require prior knowledge of its operation and where panic situations are foreseen, such as places of entertainment, public buildings and areas open to the public.

Rebated Doors

A pair of double doors that are rebated.

Non-Rebated Doors

A pair of double doors that are flush fitting.

Mechanism Unit

This is the main unit that controls the travel of the bolts and latches.

Automatic Top Trip

Device used to hold the bolts in the withdrawn position when the door is open. When the door is closed too, the automatic top trip releases the bolts securing the door.

Anti-thrust

A device built into a unit to prevent either a bolt or latch from being forced back when in the closed position, thus increasing the level of security.

Adjustable Shoots

To overcome the problem of bolts not fully engaging in the keeps due to the door or frame moving after a period of time, adjustable shoots are available on Exidor panic bolts. They allow $\pm 5\text{mm}$ of adjustment, and are particularly suited for soft wood, UPVC and steel doors.

Actuator Unit

The actuator unit connects the panic or emergency exit hardware to a mortice night latch. When used with a micro switch, the actuator unit can be connected to an electrical circuit to operate products such as an electro-magnetic Lock.

Slave Unit

The slave unit supports the cross bar on any panic hardware.

Micro Switch

For situations that require the panic hardware to be linked to a monitoring or alarm system a micro switch can be fitted in the slave unit. The micro switch closes an electrical circuit when the cross bar is operated.

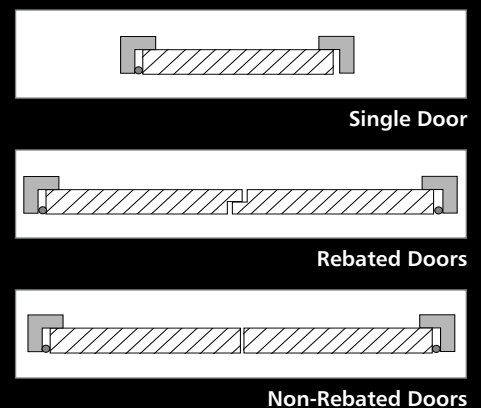

Product Features

Single doors

Product No.	Description	EN Standard		Shoot Bolts		Pullman Latches		Micro Switch	Steel Door Fixings	CE Mark	Fire Rated	Locking Points
		179	1125	Standard	Adjustable	Vertical	Horizontal					
293	Push pad single panic bolt	●		●						●	●	2
293SD	Push pad single panic bolt for steel doors	●		●					●	●	●	2
293A	Push pad single panic bolt with adjustable shoots	●			●					●	●	2
293A/SD	Push pad single panic bolt with adjustable shoots for steel doors	●			●				●	●	●	2
294	Push bar single panic bolt		●	●						●	●	2
294SD	Push bar single panic bolt for steel doors		●	●					●	●	●	2
294A	Push bar single panic bolt with adjustable shoots		●		●					●	●	2
294A/SD	Push bar single panic bolt with adjustable shoots for steel doors		●		●				●	●	●	2
294MS	Push bar single panic bolt with micro switch		●	●				●		●	●	2
294MS/SD	Push bar single panic bolt with micro switch for steel doors		●	●				●	●	●	●	2
294A/MS	Push bar single panic bolt with adjustable shoots & micro switch		●		●			●		●	●	2
294A/MS/SD	Push bar single panic bolt with adjustable shoots & micro switch for steel doors		●		●			●	●	●	●	2
296	Push bar panic latch		●							●	●	1
296SD	Push bar panic latch for steel doors		●						●	●	●	1
296MS	Push bar panic latch with micro switch		●					●		●	●	1
296MS/SD	Push bar panic latch with micro switch for steel doors		●					●	●	●	●	1
297	Push pad panic latch	●								●	●	1
297SD	Push pad panic latch for steel doors	●							●	●	●	1
301	Push bar mortice actuator only											1
301SD	Push bar mortice actuator only for steel doors								●			1
301MS	Push bar mortice actuator only with micro switch							●				1
303	Push pad mortice actuator only											1
303SD	Push pad mortice actuator only for steel doors								●			1
305	Push bar mortice actuator with night latch case		●							●		1
305SD	Push bar mortice actuator with night latch case for steel doors		●						●	●		1
305MS	Push bar mortice actuator with night latch case with micro switch		●					●		●		1
306	Push pad mortice actuator with night latch case	●								●		1
306SD	Push pad mortice actuator with night latch case for steel doors	●							●	●		1
307	Push pad single panic bolt with horizontal Pullman latches	●					●			●		2
307SD	Push pad single panic bolt with horizontal Pullman latches for steel doors	●					●		●	●		2
308	Push bar single panic bolt with horizontal Pullman latches		●				●			●		2
308SD	Push bar single panic bolt with horizontal Pullman latches for steel doors		●				●		●	●		2
310	Push pad single panic bolt with vertical Pullman latches	●				●				●	●	2
310SD	Push pad single panic bolt with vertical Pullman latches for steel doors	●				●			●	●	●	2
311	Push bar single panic bolt with vertical Pullman latches		●			●				●	●	2
311SD	Push bar single panic bolt with vertical Pullman latches for steel doors		●			●			●	●	●	2
311MS	Push bar single panic bolt with vertical Pullman latches with micro switch		●			●		●		●	●	2
311MS/SD	Push bar single panic bolt with vertical Pullman latches with micro switch for steel doors		●			●		●	●	●	●	2

Rebated double doors

Product No.	Description	EN Standard		Shoot Bolts		Pullman Latches		Micro Switch	Steel Door Fixings	CE Mark	Fire Rated	Locking Points
		179	1125	Standard	Adjustable	Vertical	Horizontal					
285	Double door set		●	●						●	●	3
285SD	Double door set for steel doors		●	●					●	●	●	3
285A	Double door set with adjustable shoots		●		●					●	●	3
285A/SD	Double door set with adjustable shoots for steel doors		●		●				●	●	●	3
285MS	Double door set with micro switches		●	●				●		●	●	3
285MS/SD	Double door set with micro switches for steel doors		●	●				●	●	●	●	3
285A/MS	Double door set with adjustable shoots & micro switch		●		●			●		●	●	3
285A/MS/SD	Double door set with adjustable shoots & micro switch for steel doors		●		●			●	●	●	●	3
309	Double door set with horizontal & vertical Pullman latches		●			●	●			●		4
309SD	Double door set with horizontal & vertical Pullman latches for steel doors		●			●	●		●	●		4
309MS	Double door set with micro switches & horizontal & vertical Pullman latches		●			●	●	●		●		4
309MS/SD	Double door set with micro switches & horizontal & vertical Pullman latches for steel doors		●			●	●	●	●	●		4
317	Double door set with vertical Pullman latches & latch		●			●				●	●	3
317SD	Double door set with vertical Pullman latches & latch for steel doors		●			●			●	●	●	3
317MS	Double door set with vertical Pullman latches & latch with micro switches		●			●		●		●	●	3
317MS/SD	Double door set with vertical Pullman latches & latch with micro switches for steel doors		●			●		●	●	●	●	3

Non-rebated double doors

Product No.	Description	EN Standard		Shoot Bolts		Pullman Latches		Micro Switch	Steel Door Fixings	CE Mark	Fire Rated	Locking Points
		179	1125	Standard	Adjustable	Vertical	Horizontal					
284	Double door set		●	●						●	●	4
284SD	Double door set for steel doors		●	●					●	●	●	4
284A	Double door set with adjustable shoots		●		●					●	●	4
284A/SD	Double door set with adjustable shoots for steel doors		●		●				●	●	●	4
284MS	Double door set with micro switches		●	●				●		●	●	4
284MS/SD	Double door set with micro switches for steel doors		●	●				●	●	●	●	4
284A/MS	Double door set with adjustable shoots & micro switches		●		●			●		●	●	4
284A/MS/SD	Double door set with adjustable shoots & micro switches for steel doors		●		●			●	●	●	●	4
316	Double door set with vertical Pullman latches		●			●				●	●	4
316MS	Double door set with micro switches with vertical Pullman latches		●			●		●		●	●	4
316MS/SD	Double door set with micro switches with vertical Pullman latches for steel doors		●			●		●	●	●	●	4

Find It Fast!

You don't need to trawl through catalogues any more. Just use the product specifiers on our new website to take you straight to the specific product you want.

exidor.co.uk



EXIDOR

**National
Seal Systems
Limited**

*Unit 210 Holly Road, Western Industrial Estate.
Naas Road, Dublin 12
Ph 00353-1-4565170 Fax 00353-1-4502371
Email: info@nationalseal.ie web: www.nationalseal.ie*



Uniclass L4181	EPIC D181
CI/SfB (31.59)	X

Issue 2 EX362

A subsidiary of
chamberlin plc

Every effort has been made to ensure the accuracy of the particulars contained in this brochure. All details and specifications were deemed correct at time of going to press. However, Exidor Limited reserve the right to alter specifications with or without prior notice and at such times in a manner they think fit. Customers are advised to call Exidor Limited on +44 (0) 1543 578661 if they require further details or clarification of specifications.